

























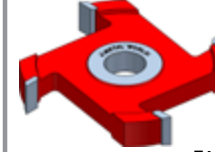
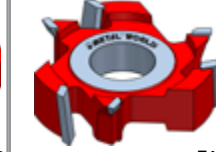
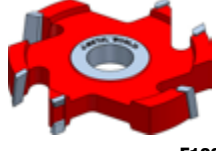
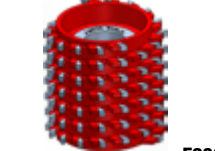











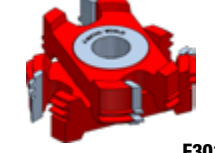

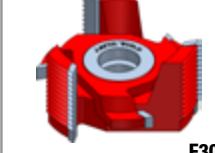



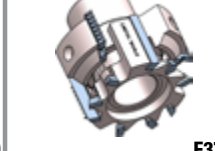

FRESATURA  
CUTTING  
FRAISAGE  
FRÄSER  
MARÓK



3

CUTTING

 FS1 p. 175	 FS1 p. 176	 FS1 p. 177	 FS2 p. 178	 FS2 p. 179	 FS2 p. 180
 FS3 p. 181	 FS3 p. 182	 FS3 p. 183	 F104 p. 184	 F106 p. 185	 F110 p. 186
 F112 p. 187	 F120 p. 188	 F130 p. 189	 F140 p. 190	 F160 p. 191	 F180 p. 192
 F190 p. 193	 F200 p. 194-195	 F210 p. 196	 F218 p. 197	 F220 p. 198	 F230 p. 199
 F240 p. 200	 F250 p. 201	 F260 p. 202	 F265 p. 203	 F290 p. 204-205	 F292 p. 206-207
 F300 p. 208	 F301 p. 209	 F304 p. 210	 F305 p. 211	 F306 p. 212-213	 F307 p. 214
 F310 p. 215	 F330 p. 216	 F340 p. 217	 F350 p. 218	 F370 p. 219	 F372 p. 220
 F374 p. 221	 F375 p. 221	 F378 p. 222	 F382 p. 223	 F400 p. 224	 F410 p. 224























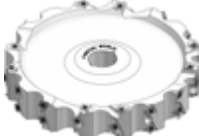

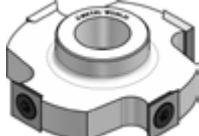



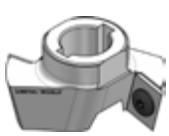



CUTTING

 <b>F420</b> p. 225	 <b>F435</b> p. 226	 <b>F480</b> p. 226	 <b>F495</b> p. 227	 <b>TS2</b> p. 229	 <b>TS3</b> p. 230
 <b>TS4</b> p. 231	 <b>TS6</b> p. 232	 <b>T108</b> p. 233	 <b>T109</b> p. 234	 <b>M788</b> p. 234	 <b>T110</b> p. 235
 <b>T112</b> p. 236	 <b>T114</b> p. 237	 <b>T120</b> p. 238	 <b>T122</b> p. 239	 <b>T140</b> p. 240	 <b>T130</b> p. 241
 <b>T160</b> p. 242	 <b>T174</b> p. 243	 <b>T180</b> p. 244	 <b>T182</b> p. 245	 <b>T190</b> p. 246	 <b>T192</b> p. 247
 <b>T195</b> p. 248	 <b>T198</b> p. 249	 <b>T198H</b> p. 250	 <b>T200</b> p. 251	 <b>T201</b> p. 252	 <b>T202</b> p. 253
 <b>T202H</b> p. 254	 <b>T203</b> p. 255	 <b>T203H</b> p. 256	 <b>T204</b> p. 257	 <b>T204H</b> p. 258-259	 <b>T204C</b> p. 260
 <b>T207</b> p. 261	 <b>T207H</b> p. 262-263	 <b>T207W</b> p. 264	 <b>T207C</b> p. 265	 <b>T207R</b> p. 266	 <b>T207RC</b> p. 267
 <b>T210</b> p. 268	 <b>T216</b> p. 269	 <b>T216</b> p. 270	 <b>T216</b> p. 271	 <b>T218</b> p. 272	 <b>T219</b> p. 273

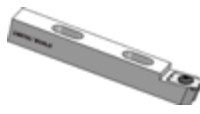

CUTTING

 <b>T206</b> p. 274	 <b>T206H</b> p. 275	 <b>T206W</b> p. 276	 <b>T208</b> p. 277	 <b>T208W</b> p. 278	 <b>T209</b> p. 279
 <b>T220</b> p. 280	 <b>T265</b> p. 281	 <b>T300</b> p. 282	 <b>T310</b> p. 283	 <b>T330</b> p. 284	 <b>T382</b> p. 286
 <b>T384</b> p. 287	 <b>T386</b> p. 288	 <b>T400</b> p. 289-290-291	 <b>T404</b> p. 292	 <b>T408</b> p. 293	 <b>T410</b> p. 294
 <b>T410</b> p. 295	 <b>T420</b> p. 296	 <b>T430</b> p. 297	 <b>T430</b> p. 298	 <b>T435</b> p. 299	 <b>T440</b> p. 300
 <b>T440</b> p. 301	 <b>T440</b> p. 302	 <b>T441</b> p. 303	 <b>T442</b> p. 304	 <b>T442</b> p. 305	 <b>T446</b> p. 306
 <b>T450</b> p. 307	 <b>T480</b> p. 308	 <b>T490</b> p. 309	 <b>T492</b> p. 310	 <b>T494</b> p. 311	



# FS1

## HW Egyszerű profilú marók



Edzett acélból készült test • 3 beforrasztott vágóél • Asztali marókra, formázó marókra, kettős végprofilírozó stb. gépekre szerelhető fel • Egyedi igény esetén a marók gyorsacél (HS) vágóélekkel is szállíthatók

Body in hardened and tempered steel • 3 HW brazed cutting edges • To be mounted on toupie, moulding machines, double end tenoner machines, etc. • On request the cutters can be supplied with HS cutting edges

Z=3

● = Készleten van   ■ = Szállítási idő 20 munkanap   ▲ = Rendelésre

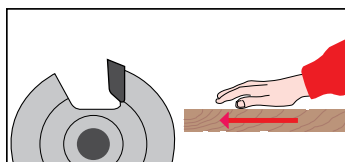
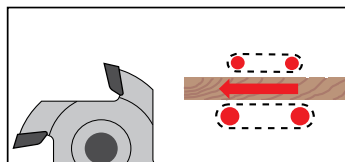
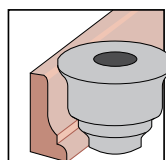
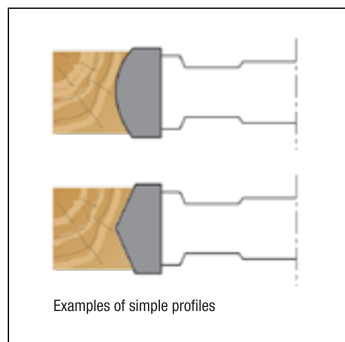
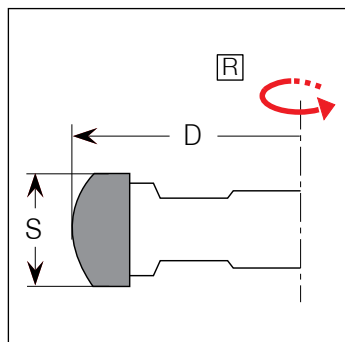

D	S	F	Cikkszám
120	20	30	▲ FS13M1200203
120	25	30	▲ FS13M1200253
120	30	30	▲ FS13M1200303
120	35	30	▲ FS13M1200353
120	40	30	▲ FS13M1200403
120	50	30	▲ FS13M1200503
120	60	30	▲ FS13M1200603
120	70	30	▲ FS13M1200703
120	80	30	▲ FS13M1200803
120	90	30	▲ FS13M1200903
120	100	30	▲ FS13M1201003
160	20	30	▲ FS13M1600203
160	25	30	▲ FS13M1600253
160	30	30	▲ FS13M1600303
160	35	30	▲ FS13M1600353
160	40	30	▲ FS13M1600403
160	50	30	▲ FS13M1600503
160	60	30	▲ FS13M1600603
160	70	30	▲ FS13M1600703
160	80	30	▲ FS13M1600803
160	90	30	▲ FS13M1600903
160	100	30	▲ FS13M1601003
200	20	30	▲ FS13M2000203
200	25	30	▲ FS13M2000253
200	30	30	▲ FS13M2000303
200	35	30	▲ FS13M2000353
200	40	30	▲ FS13M2000403
200	50	30	▲ FS13M2000503
200	60	30	▲ FS13M2000603
200	70	30	▲ FS13M2000703
200	80	30	▲ FS13M2000803
200	90	30	▲ FS13M2000903
200	100	30	▲ FS13M2001003
Spec. HW			FS13M99
Spec. HS			FS13S99

TAGLIO / SEZIONATURA  
SAWING

DIAMANTE  
DIAMOND

FRESATURA  
CUTTING

PANTOGRAFATURA  
ROUTING

FORATURA  
BORING

MANDRINI / ATTACCHI  
CHUCKS & CLAMPING SYSTEM

RICAMBI E LAVORAZIONI SUPP.  
SPARE PARTS & ADD. WORKING

Forrasztottlapkás marók egyszerű profilal

Sonder - Profilfräser (Einfaches Profil)

Fraise avec profil sample HW

Профильные фрезы

**FS1**

**HW** Egyszerű profilú marók



Edzett acélból készült test • 4 beforrasztott vágóél • Asztali marókra, formázó marókra, kettős végprofilírozó stb. gépekre szerelhető fel • Egyedi igény esetén a marók gyorsacél (HS) vágóélekkel is szállíthatók

Body in hardened and tempered steel • 4 HW brazed cutting edges • To be mounted on toupie, moulding machines, double end tenoner machines, etc. • On request the cutters can be supplied with HS cutting edges

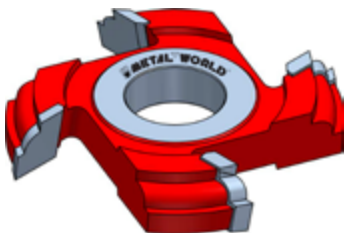

TAGLIO / SEZIONATURA SAWING

DIAMANTE DIAMOND

FRESATURA CUTTING

PANTOGRAFATURA ROUTING

FORATURA BORING

MANDRINI / ATTACCHI CHUCKS & CLAMPING SYSTEM

RICAMBI E LAVORAZIONI SUPP. SPARE PARTS & ADD. WORKING

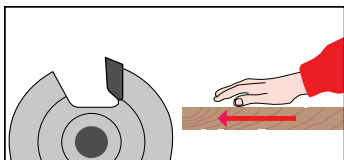
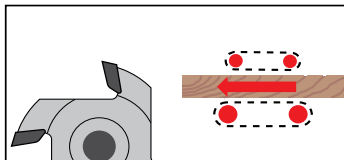
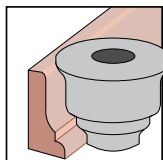
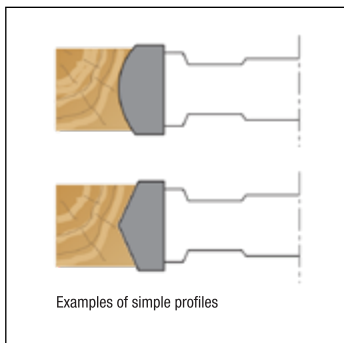
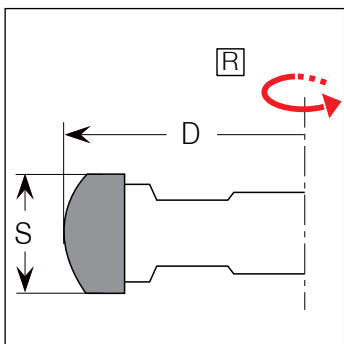

**Z=4**

● = Készleten van

■ = Szállítási idő 20 munkanap

△ = Rendelésre

D	S	F	Cikkszám
120	20	30	△ FS14M1200204
120	25	30	△ FS14M1200254
120	30	30	△ FS14M1200304
120	35	30	△ FS14M1200354
120	40	30	△ FS14M1200404
120	50	30	△ FS14M1200504
120	60	30	△ FS14M1200604
120	70	30	△ FS14M1200704
120	80	30	△ FS14M1200804
120	90	30	△ FS14M1200904
120	100	30	△ FS14M1201004
160	20	30	△ FS14M1600204
160	25	30	△ FS14M1600254
160	30	30	△ FS14M1600304
160	35	30	△ FS14M1600354
160	40	30	△ FS14M1600404
160	50	30	△ FS14M1600504
160	60	30	△ FS14M1600604
160	70	30	△ FS14M1600704
160	80	30	△ FS14M1600804
160	90	30	△ FS14M1600904
160	100	30	△ FS14M1601004
200	20	30	△ FS14M2000204
200	25	30	△ FS14M2000254
200	30	30	△ FS14M2000304
200	35	30	△ FS14M2000354
200	40	30	△ FS14M2000404
200	50	30	△ FS14M2000504
200	60	30	△ FS14M2000604
200	70	30	△ FS14M2000704
200	80	30	△ FS14M2000804
200	90	30	△ FS14M2000904
200	100	30	△ FS14M2001004
Spec. HW			FS14M99
Spec. HS			FS14S99



# FS1

## HW Egyszerű profilú marók

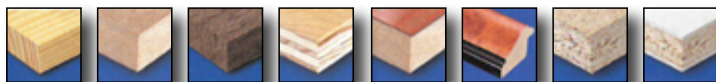

Edzett acélból készült test • 6 beforrasztott vidia vágóél • Asztali marókra, formázó marókra, kettős végprofilírozó stb. gépekre szerelhető fel • Egyedi igény esetén a marók gyorsacél (HS) vágóélekkel is szállíthatók

Body in hardened and tempered steel • 6 HW brazed cutting edges • To be mounted on toupie, moulding machines, double end tenoner machines, etc. • On request the cutters can be supplied with HS cutting edges

Z=6

● = Készleten van ■ = Szállítási idő 20 munkanap ▲ = Rendelésre

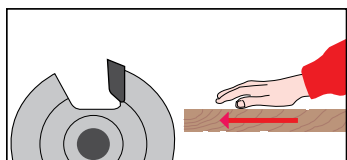
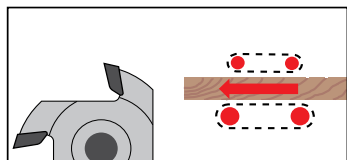
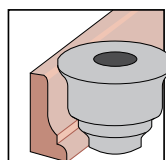
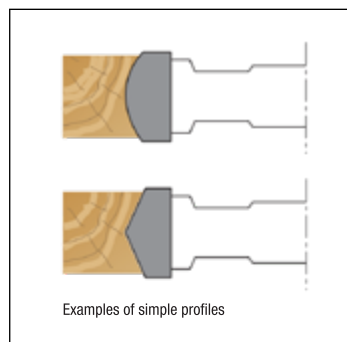
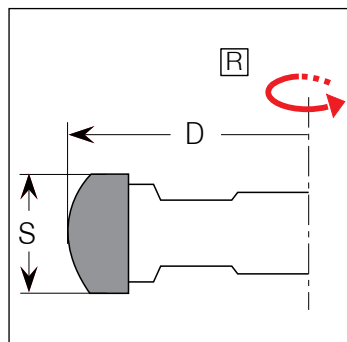

D	S	F	Cikkszám
120	20	30	▲ FS16M1200206
120	25	30	▲ FS16M1200256
120	30	30	▲ FS16M1200306
120	35	30	▲ FS16M1200356
120	40	30	▲ FS16M1200406
120	50	30	▲ FS16M1200506
120	60	30	▲ FS16M1200606
120	70	30	▲ FS16M1200706
120	80	30	▲ FS16M1200806
120	90	30	▲ FS16M1200906
120	100	30	▲ FS16M1201006
160	20	30	▲ FS16M1600206
160	25	30	▲ FS16M1600256
160	30	30	▲ FS16M1600306
160	35	30	▲ FS16M1600356
160	40	30	▲ FS16M1600406
160	50	30	▲ FS16M1600506
160	60	30	▲ FS16M1600606
160	70	30	▲ FS16M1600706
160	80	30	▲ FS16M1600806
160	90	30	▲ FS16M1600906
160	100	30	▲ FS16M1601006
200	20	30	▲ FS16M2000206
200	25	30	▲ FS16M2000256
200	30	30	▲ FS16M2000306
200	35	30	▲ FS16M2000356
200	40	30	▲ FS16M2000406
200	50	30	▲ FS16M2000506
200	60	30	▲ FS16M2000606
200	70	30	▲ FS16M2000706
200	80	30	▲ FS16M2000806
200	90	30	▲ FS16M2000906
200	100	30	▲ FS16M2001006
Spec. HW			FS16M99
Spec. HS			FS16S99

TAGLIO / SEZIONATURA  
SAWING

DIAMANTE  
DIAMOND

FRESATURA  
CUTTING

PANTOGRAFATURA  
ROUTING

FORATURA  
BORING

MANDRINI / ATTACCHI  
CHUCKS & CLAMPING SYSTEM

RICAMBI E LAVORAZIONI SUPP.  
SPARE PARTS & ADD. WORKING

Forrasztottlapkás marók összetett profilal

Sonder - Profilfräser (Komplexes Profil)

Fraise avec profil complex HW

Профильные фрезы

**FS2**

**HW** Összetett profilú marók



Edzett acélból készült test • 3 beforrasztott vídia vágóél • Asztali marókra, formázó marókra, kettős végprofilírozó stb. gépekre szerelhető fel • Egyedi igény esetén a marók gyorsacél (HS) vágóélekkel is szállíthatók

Body in hardened and tempered steel • 3 HW brazed cutting edges • To be mounted on toupie, moulding machines, double end tenoner machines, etc. • On request the cutters can be supplied with HS cutting edges



**Z=3**

● = Készleten van

■ = Szállítási idő 20 munkanap

△ = Rendelésre

D	S	F	Cikkszám
120	20	30	△ FS23M1200203
120	25	30	△ FS23M1200253
120	30	30	△ FS23M1200303
120	35	30	△ FS23M1200353
120	40	30	△ FS23M1200403
120	50	30	△ FS23M1200503
120	60	30	△ FS23M1200603
120	70	30	△ FS23M1200703
120	80	30	△ FS23M1200803
120	90	30	△ FS23M1200903
120	100	30	△ FS23M1201003
160	20	30	△ FS23M1600203
160	25	30	△ FS23M1600253
160	30	30	△ FS23M1600303
160	35	30	△ FS23M1600353
160	40	30	△ FS23M1600403
160	50	30	△ FS23M1600503
160	60	30	△ FS23M1600603
160	70	30	△ FS23M1600703
160	80	30	△ FS23M1600803
160	90	30	△ FS23M1600903
160	100	30	△ FS23M1601003
200	20	30	△ FS23M2000203
200	25	30	△ FS23M2000253
200	30	30	△ FS23M2000303
200	35	30	△ FS23M2000353
200	40	30	△ FS23M2000403
200	50	30	△ FS23M2000503
200	60	30	△ FS23M2000603
200	70	30	△ FS23M2000703
200	80	30	△ FS23M2000803
200	90	30	△ FS23M2000903
200	100	30	△ FS23M2001003
Spec. HW			FS23M99
Spec. HS			FS23S99

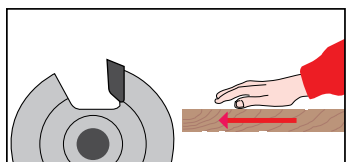
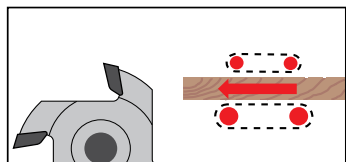
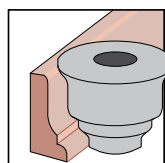
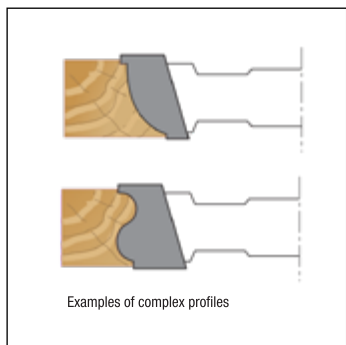
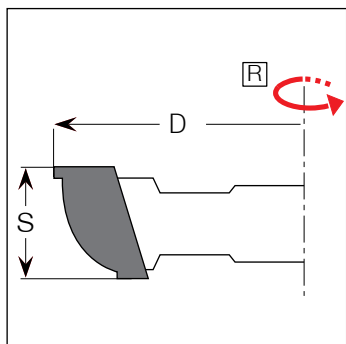

TAGLIO / SEZIONATURA  
SAWING

DIAMANTE  
DIAMOND

FRESATURA  
CUTTING

PANTOGRAFATURA  
ROUTING

FORATURA  
BORING

MANDRINI / ATTACCHI  
CHUCKS & CLAMPING SYSTEM

RICAMBI E LAVORAZIONI SUPP.  
SPARE PARTS & ADD. WORKING





# FS2 HW Összetett profilú marók

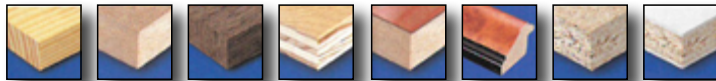

Edzett acélból készült test • 4 beforrasztott vágóél • Asztali marókra, formázó marókra, kettős végprofilírozó stb. gépekre szerelhető fel • Egyedi igény esetén a marók gyorsacél (HS) vágóélekkel is szállíthatók

Body in hardened and tempered steel • 4 HW brazed cutting edges • To be mounted on toupie, moulding machines, double end tenoner machines, etc. • On request the cutters can be supplied with HS cutting edges

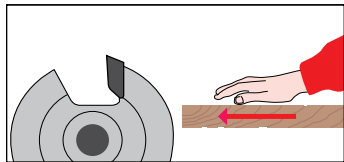
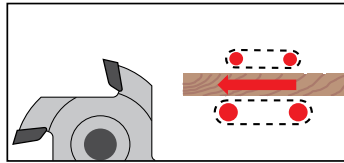
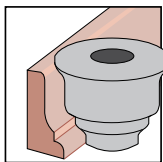
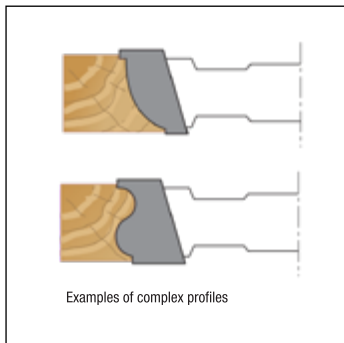
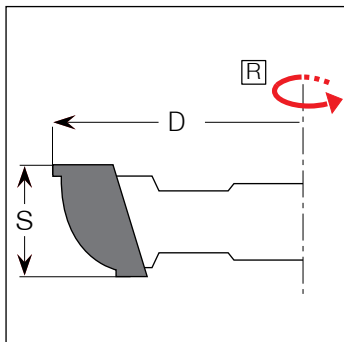

Z=4

● = Készleten van ■ = Szállítási idő 20 munkanap ▲ = Rendelésre

D	S	F	Cikkszám
120	20	30	▲ FS24M1200204
120	25	30	▲ FS24M1200254
120	30	30	▲ FS24M1200304
120	35	30	▲ FS24M1200354
120	40	30	▲ FS24M1200404
120	50	30	▲ FS24M1200504
120	60	30	▲ FS24M1200604
120	70	30	▲ FS24M1200704
120	80	30	▲ FS24M1200804
120	90	30	▲ FS24M1200904
120	100	30	▲ FS24M1201004
160	20	30	▲ FS24M1600204
160	25	30	▲ FS24M1600254
160	30	30	▲ FS24M1600304
160	35	30	▲ FS24M1600354
160	40	30	▲ FS24M1600404
160	50	30	▲ FS24M1600504
160	60	30	▲ FS24M1600604
160	70	30	▲ FS24M1600704
160	80	30	▲ FS24M1600804
160	90	30	▲ FS24M1600904
160	100	30	▲ FS24M1601004
200	20	30	▲ FS24M2000204
200	25	30	▲ FS24M2000254
200	30	30	▲ FS24M2000304
200	35	30	▲ FS24M2000354
200	40	30	▲ FS24M2000404
200	50	30	▲ FS24M2000504
200	60	30	▲ FS24M2000604
200	70	30	▲ FS24M2000704
200	80	30	▲ FS24M2000804
200	90	30	▲ FS24M2000904
200	100	30	▲ FS24M2001004
Spec. HW			FS24M99
Spec. HS			FS24S99

TAGLIO / SEZIONATURA SAWING

DIAMANTE DIAMOND

FRESATURA CUTTING

PANTOGRAFATURA ROUTING

FORATURA BORING

MANDRINI / ATTACCHI CHUCKS & CLAMPING SYSTEM

RICAMBI E LAVORAZIONI SUPP. SPARE PARTS & ADD. WORKING

Forrasztottlapkás marók összetett profilal

Sonder - Profilfräser (Komplexes Profil)

Fraise avec profil complex HW

Профильные фрезы

**FS2**

**HW** Összetett profilú marók



Edzett acélból készült test • 6 beforrasztott vidia vágóél • Asztali marókra, formázó marókra, kettős végprofilírozó stb. gépekre szerelhető fel • Egyedi igény esetén a marók gyorsacél (HS) vágóélekkel is szállíthatók

Body in hardened and tempered steel • 6 HW brazed cutting edges • To be mounted on toupie, moulding machines, double end tenoner machines, etc. • On request the cutters can be supplied with HS cutting edges



TAGLIO / SEZIONATURA SAWING

DIAMANTE DIAMOND

FRESATURA CUTTING

PANTOGRAFATURA ROUTING

FORATURA BORING

MANDRINI / ATTACCHI CHUCKS & CLAMPING SYSTEM

RICAMBI E LAVORAZIONI SUPP. SPARE PARTS & ADD. WORKING

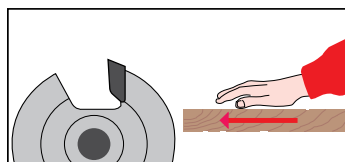
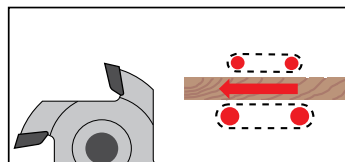
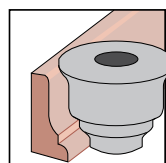
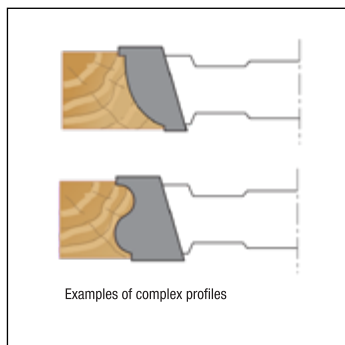
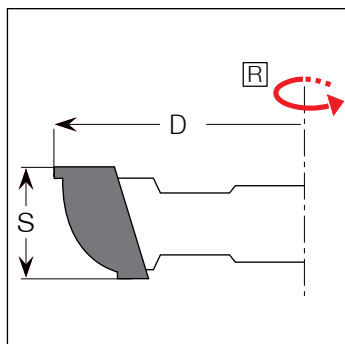

**Z=6**

● = Készleten van

■ = Szállítási idő 20 munkanap

△ = Rendelésre

D	S	F	Cikkszám
120	20	30	△ FS26M1200206
120	25	30	△ FS26M1200256
120	30	30	△ FS26M1200306
120	35	30	△ FS26M1200356
120	40	30	△ FS26M1200406
120	50	30	△ FS26M1200506
120	60	30	△ FS26M1200606
120	70	30	△ FS26M1200706
120	80	30	△ FS26M1200806
120	90	30	△ FS26M1200906
120	100	30	△ FS26M1201006
160	20	30	△ FS26M1600206
160	25	30	△ FS26M1600256
160	30	30	△ FS26M1600306
160	35	30	△ FS26M1600356
160	40	30	△ FS26M1600406
160	50	30	△ FS26M1600506
160	60	30	△ FS26M1600606
160	70	30	△ FS26M1600706
160	80	30	△ FS26M1600806
160	90	30	△ FS26M1600906
160	100	30	△ FS26M1601006
200	20	30	△ FS26M2000206
200	25	30	△ FS26M2000256
200	30	30	△ FS26M2000306
200	35	30	△ FS26M2000356
200	40	30	△ FS26M2000406
200	50	30	△ FS26M2000506
200	60	30	△ FS26M2000606
200	70	30	△ FS26M2000706
200	80	30	△ FS26M2000806
200	90	30	△ FS26M2000906
200	100	30	△ FS26M2001006
Spec. HW			FS26M99
Spec. HS			FS26S99



# FS3 HW Nagyon összetett profilú marók

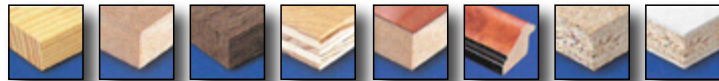

Edzett acélból készült test • 3 beforrasztott vidia vágóél • Asztali marókra, formázó marókra, kettős végprofilírozó stb. gépekre szerelhetők fel • Egyedi igény esetén a marók gyorsacél (HS) vágóélékkel is szállíthatók

Body in hardened and tempered steel • 3 HW brazed cutting edges • To be mounted on toupie, moulding machines, double end tenoner machines, etc. • On request the cutters can be supplied with HS cutting edges

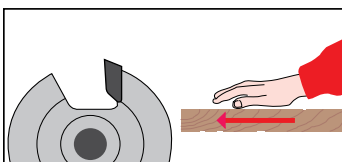
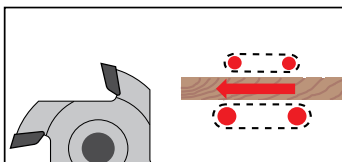
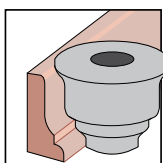
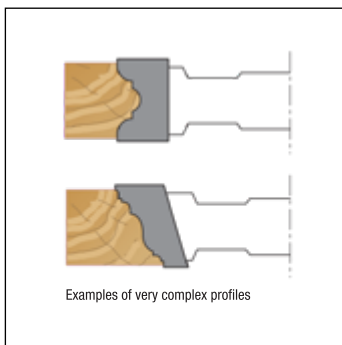
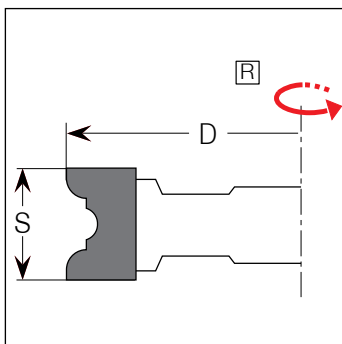

Z=3

● = Készleten van ■ = Szállítási idő 20 munkanap ▲ = Rendelésre

D	S	F	Cikkszám
120	20	30	▲ FS33M1200203
120	25	30	▲ FS33M1200253
120	30	30	▲ FS33M1200303
120	35	30	▲ FS33M1200353
120	40	30	▲ FS33M1200403
120	50	30	▲ FS33M1200503
120	60	30	▲ FS33M1200603
120	70	30	▲ FS33M1200703
120	80	30	▲ FS33M1200803
120	90	30	▲ FS33M1200903
120	100	30	▲ FS33M1201003
160	20	30	▲ FS33M1600203
160	25	30	▲ FS33M1600253
160	30	30	▲ FS33M1600303
160	35	30	▲ FS33M1600353
160	40	30	▲ FS33M1600403
160	50	30	▲ FS33M1600503
160	60	30	▲ FS33M1600603
160	70	30	▲ FS33M1600703
160	80	30	▲ FS33M1600803
160	90	30	▲ FS33M1600903
160	100	30	▲ FS33M1601003
200	20	30	▲ FS33M2000203
200	25	30	▲ FS33M2000253
200	30	30	▲ FS33M2000303
200	35	30	▲ FS33M2000353
200	40	30	▲ FS33M2000403
200	50	30	▲ FS33M2000503
200	60	30	▲ FS33M2000603
200	70	30	▲ FS33M2000703
200	80	30	▲ FS33M2000803
200	90	30	▲ FS33M2000903
200	100	30	▲ FS33M2001003
Spec. HW			FS33M99
Spec. HS			FS33S99

TAGLIO / SEZIONATURA SAWING

DIAMANTE DIAMOND

FRESATURA CUTTING

PANTOGRAFATURA ROUTING

FORATURA BORING

MANDRINI / ATTACCHI CHUCKS & CLAMPING SYSTEM

RICAMBI E LAVORAZIONI SUPP. SPARE PARTS & ADD. WORKING

Forrasztottlapkás  
marók nagyon  
összetett profilal

Sonder - Profilfräser  
(Sehr komplexes Profil)

Fraise avec profil tres complex  
HW

Профильные фрезы

**FS3**

**HW** Nagyon összetett profilú marók

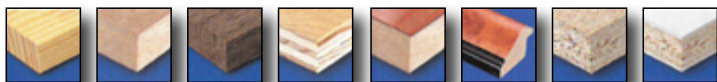

Edzett acélból készült test • 4 beforrasztott vágóél • Asztali marókra, formázó marókra, kettős végprofilírozó stb. gépekre szerelhetők fel • Egyedi igény esetén a marók gyorsacél (HS) vágóélékkel is szállíthatók

Body in hardened and tempered steel • 4 HW brazed cutting edges • To be mounted on toupie, moulding machines, double end tenoner machines, etc. • On request the cutters can be supplied with HS cutting edges



**Z=4**

● = Készleten van

■ = Szállítási idő 20 munkanap

△ = Rendelésre

D	S	F	Cikkszám
120	20	30	△ FS34M1200204
120	25	30	△ FS34M1200254
120	30	30	△ FS34M1200304
120	35	30	△ FS34M1200354
120	40	30	△ FS34M1200404
120	50	30	△ FS34M1200504
120	60	30	△ FS34M1200604
120	70	30	△ FS34M1200704
120	80	30	△ FS34M1200804
120	90	30	△ FS34M1200904
120	100	30	△ FS34M1201004
160	20	30	△ FS34M1600204
160	25	30	△ FS34M1600254
160	30	30	△ FS34M1600304
160	35	30	△ FS34M1600354
160	40	30	△ FS34M1600404
160	50	30	△ FS34M1600504
160	60	30	△ FS34M1600604
160	70	30	△ FS34M1600704
160	80	30	△ FS34M1600804
160	90	30	△ FS34M1600904
160	100	30	△ FS34M1601004
200	20	30	△ FS34M2000204
200	25	30	△ FS34M2000254
200	30	30	△ FS34M2000304
200	35	30	△ FS34M2000354
200	40	30	△ FS34M2000404
200	50	30	△ FS34M2000504
200	60	30	△ FS34M2000604
200	70	30	△ FS34M2000704
200	80	30	△ FS34M2000804
200	90	30	△ FS34M2000904
200	100	30	△ FS34M2001004
Spec. HW			FS34M99
Spec. HS			FS34S99

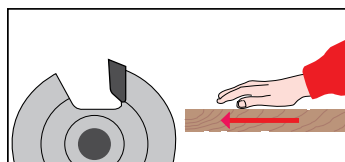
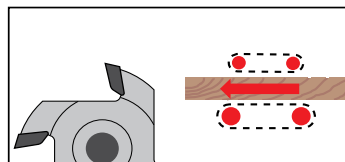
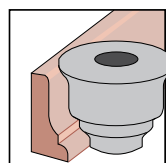
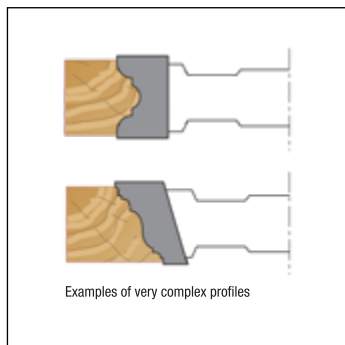
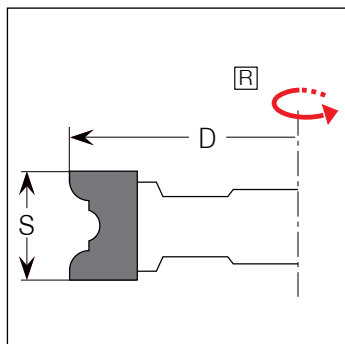

TAGLIO / SEZIONATURA  
SAWING

DIAMANTE  
DIAMOND

FRESATURA  
CUTTING

PANTOGRAFATURA  
ROUTING

FORATURA  
BORING

MANDRINI / ATTACCHI  
CHUCKS & CLAMPING SYSTEM

RICAMBI E LAVORAZIONI SUPP.  
SPARE PARTS & ADD. WORKING



# FS3

## HW Nagyon összetett profilú marók

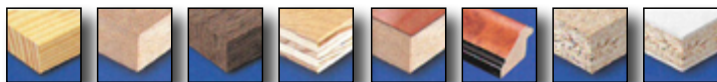

Edzett acélból készült test • 6 beforrasztott vidia vágóél • Asztali marókra, formázó marókra, kettős végprofilozó stb. gépekre szerelhetők fel • Egyedi igény esetén a marók gyorsacél (HS) vágóélekkel is szállíthatók

Body in hardened and tempered steel • 6 HW brazed cutting edges • To be mounted on toupie, moulding machines, double end tenoner machines, etc. • On request the cutters can be supplied with HS cutting edges

Z=6

● = Készleten van ■ = Szállítási idő 20 munkanap ▲ = Rendelésre

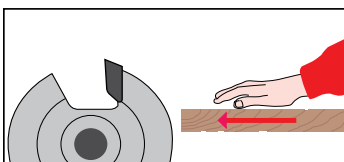
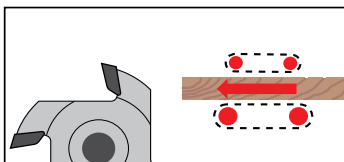
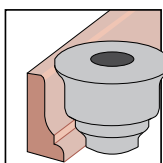
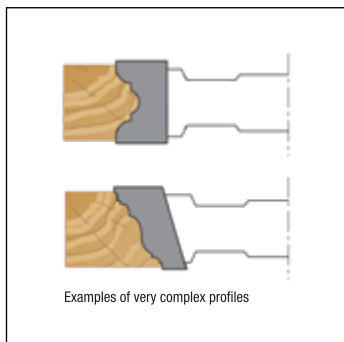
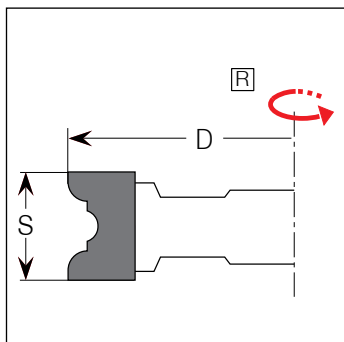

D	S	F	Cikkszám
120	20	30	▲ FS36M1200206
120	25	30	▲ FS36M1200256
120	30	30	▲ FS36M1200306
120	35	30	▲ FS36M1200356
120	40	30	▲ FS36M1200406
120	50	30	▲ FS36M1200506
120	60	30	▲ FS36M1200606
120	70	30	▲ FS36M1200706
120	80	30	▲ FS36M1200806
120	90	30	▲ FS36M1200906
120	100	30	▲ FS36M1201006
160	20	30	▲ FS36M1600206
160	25	30	▲ FS36M1600256
160	30	30	▲ FS36M1600306
160	35	30	▲ FS36M1600356
160	40	30	▲ FS36M1600406
160	50	30	▲ FS36M1600506
160	60	30	▲ FS36M1600606
160	70	30	▲ FS36M1600706
160	80	30	▲ FS36M1600806
160	90	30	▲ FS36M1600906
160	100	30	▲ FS36M1601006
200	20	30	▲ FS36M2000206
200	25	30	▲ FS36M2000256
200	30	30	▲ FS36M2000306
200	35	30	▲ FS36M2000356
200	40	30	▲ FS36M2000406
200	50	30	▲ FS36M2000506
200	60	30	▲ FS36M2000606
200	70	30	▲ FS36M2000706
200	80	30	▲ FS36M2000806
200	90	30	▲ FS36M2000906
200	100	30	▲ FS36M2001006
Spec. HW			FS36M99
Spec. HS			FS36S99

TAGLIO / SEZIONATURA SAWING

DIAMANTE DIAMOND

FRESATURA CUTTING

PANTOGRAFATURA ROUTING

FORATURA BORING

MANDRINI / ATTACCHI CHUCKS & CLAMPING SYSTEM

RICAMBI E LAVORAZIONI SUPP. SPARE PARTS & ADD. WORKING

Horonymarók  
elővágó nélkül

Nut-Fräskopf  
ohne Vorschneider

Fraises a rainer HW

Пазовые фрезы HW

**F104**

**HW Horonymarók**

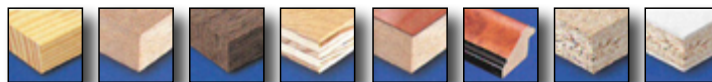

Edzett acélból készült test • 4 beforrasztott vídia vágóél • Hornyok kivitelezésére alkalmas • Asztali marókon, formázó marókon, stb. használható • Egyedi igény esetén a marók gyorsacél (HS) vágóélékkel is szállíthatók

Body in hardened and tempered steel • 4 HW brazed cutting edges • Suitable for the execution of joints • Can be used on toupie, moulding machines, etc. • On request the cutters can be supplied with HS cutting edges



**Z=4**

● = Készleten van

■ = Szállítási idő 20 munkanap

△ = Rendelésre

D	S	F	Cikkszám
120	4	30	△ F104M1200404
120	6	30	△ F104M1200604
120	8	30	△ F104M1200804
120	10	30	△ F104M1201004
120	12	30	△ F104M1201204
120	14	30	△ F104M1201404
140	4	30	△ F104M1400404
140	6	30	△ F104M1400604
140	8	30	△ F104M1400804
140	10	30	△ F104M1401004
140	12	30	△ F104M1401204
140	14	30	△ F104M1401404
160	4	30	△ F104M1600404
160	6	30	△ F104M1600604
160	8	30	△ F104M1600804
160	10	30	△ F104M1601004
160	12	30	△ F104M1601204
160	14	30	△ F104M1601404
Spec. HW			F104M99
Spec. HS			F104S99

TAGLIO / SEZIONATURA  
SAWING

DIAMANTE  
DIAMOND

FRESATURA  
CUTTING

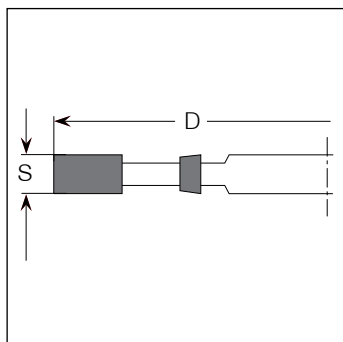

PANTOGRAFATURA  
ROUTING

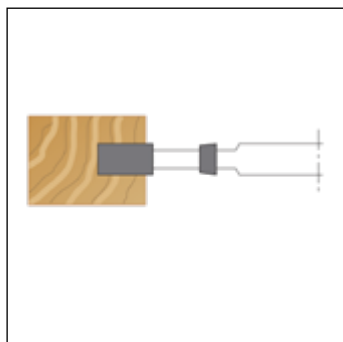

FORATURA  
BORING

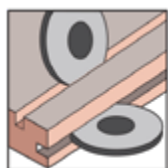

MANDRINI / ATTACCHI  
CHUCKS & CLAMPING SYSTEM

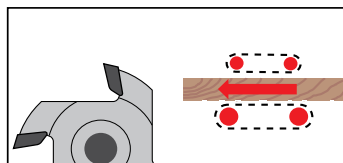

RICAMBI E LAVORAZIONI SUPP.  
SPARE PARTS & ADD. WORKING

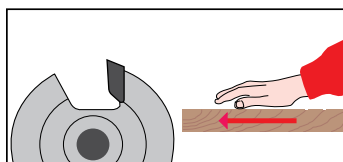

Horonymarók  
elővágó nélkül

Nut-Fräskopf  
ohne Vorschneider

Fraises a rainer HW

Пазовые фрезы HW

**F106**

**HW Horonymarók**

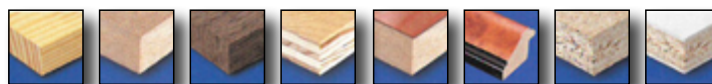

Edzett acélból készült test • 6 beforrasztott vágóél • Hornyok kivitelezésére alkalmas • Asztali marókon, formázó marókon, stb. használható • Egyedi igény esetén a marók gyorsacél (HS) vágóélekkel is szállíthatók

Body in hardened and tempered steel • 6 HW brazed cutting edges • Suitable for the execution of joints • Can be used on toupie, moulding machines, etc. • On request the cutters can be supplied with HS cutting edges

**Z=6**

● = Készleten van ■ = Szállítási idő 20 munkanap ▲ = Rendelésre

D	S	F	Cikkszám
120	4	30	▲ F106M1200406
120	6	30	▲ F106M1200606
120	8	30	▲ F106M1200806
120	10	30	▲ F106M1201006
120	12	30	▲ F106M1201206
120	14	30	▲ F106M1201406
140	4	30	▲ F106M1400406
140	6	30	▲ F106M1400606
140	8	30	▲ F106M1400806
140	10	30	▲ F106M1401006
140	12	30	▲ F106M1401206
140	14	30	▲ F106M1401406
160	4	30	▲ F106M1600406
160	6	30	▲ F106M1600606
160	8	30	▲ F106M1600806
160	10	30	▲ F106M1601006
160	12	30	▲ F106M1601206
160	14	30	▲ F106M1601406
Spec. HW			F106M99
Spec. HS			F106S99

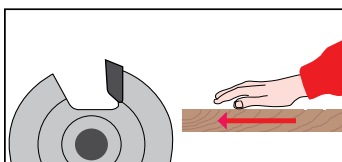
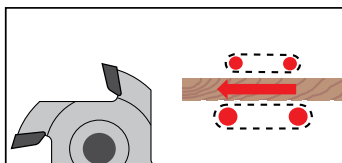
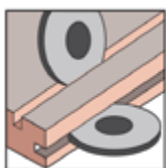
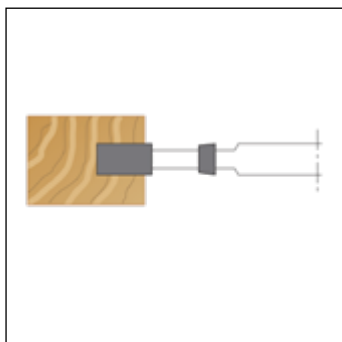
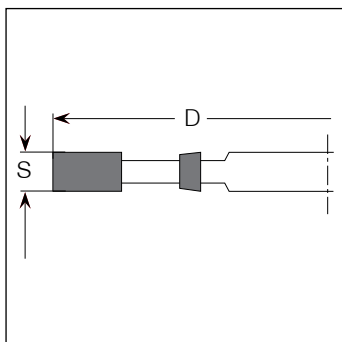

TAGLIO / SEZIONATURA  
SAWING

DIAMANTE  
DIAMOND

FRESATURA  
CUTTING

PANTOGRAFATURA  
ROUTING

FORATURA  
BORING

MANDRINI / ATTACCHI  
CHUCKS & CLAMPING SYSTEM

RICAMBI E LAVORAZIONI SUPP.  
SPARE PARTS & ADD. WORKING

Horonymarók elővágóval

Nutfräser mit Vorschneider

Fraises a rainier avec araseurs HW

Пазовые фрезы с подрезными ножами HW

**F110**

**HW Horonymarók elővágóval**

TAGLIO / SEZIONATURA  
SAWING

DIAMANTE  
DIAMOND

FRESATURA  
CUTTING

PANTOGRAFATURA  
ROUTING

FORATURA  
BORING

MANDRINI / ATTACCHI  
CHUCKS & CLAMPING SYSTEM

RICAMBI E LAVORAZIONI SUPP.  
SPARE PARTS & ADD. WORKING



Edzett acélból készült test • 4 vágó + 4 elővágó beforrasztott vidia él • Kiváló felületminőség • Fix szélességű horonyok kivitelezésére alkalmas • Asztali marókon, for- mázó marókon, stb. használható • Egyedi igény esetén a marók gyorsacél (HS) vágóélekkel és elővágó éllel is szállíthatók

Body in hardened and tempered steel • 4 cutting edges + 4 spurs brazed in HW • Excellent finish • Suitable for running grooves fixed thickness • Can be used on toupie, moulding machines, etc. • On request the cutters can be supplied with HS cutting edges

**Z=4+4**

● = Készleten van

■ = Szállítási idő 20 munkanap

△ = Rendelésre

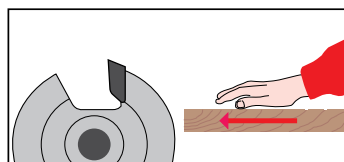
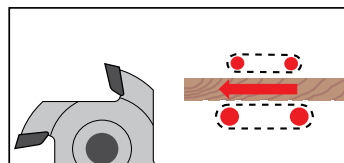
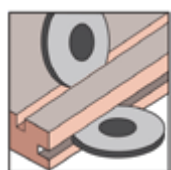
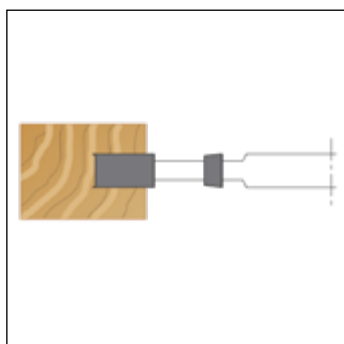
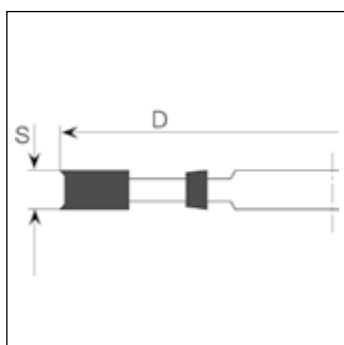

D	S	F	Cikkszám
120	4	30	△ F110M12004AA
120	5	30	△ F110M12005AA
120	6	30	△ F110M12006AA
120	8	30	△ F110M12008AA
120	10	30	△ F110M12010AA
120	12	30	△ F110M12012AA
120	14	30	△ F110M12014AA
140	4	30	△ F110M14004AA
140	5	30	△ F110M14005AA
140	6	30	△ F110M14006AA
140	8	30	△ F110M14008AA
140	10	30	△ F110M14010AA
140	12	30	△ F110M14012AA
140	14	30	△ F110M14014AA
160	4	30	△ F110M16004AA
160	5	30	△ F110M16005AA
160	6	30	△ F110M16006AA
160	8	30	△ F110M16008AA
160	10	30	△ F110M16010AA
160	12	30	△ F110M16012AA
160	14	30	△ F110M16014AA
200	4	40	△ F110M20004AA
200	5	40	△ F110M20005AA
200	6	40	△ F110M20006AA
200	8	40	△ F110M20008AA
200	10	40	△ F110M20010AA
200	12	40	△ F110M20012AA
200	14	40	△ F110M20014AA
Spec. HW			F110M99
Spec. HS			F110S99



Horonymarók  
elővágó nélkül

Nut-Fräskopf  
ohne Vorschneider

Fraises a rainier HW

Пазовые фрезы HW

**F112**

**HW Horonymarók**

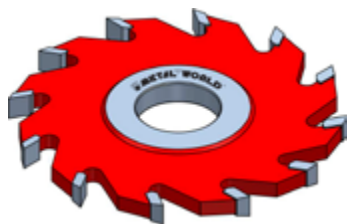
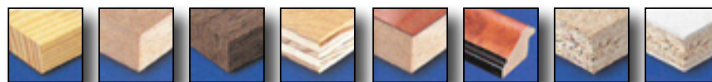

Edzett acélból készült test • 12 beforrasztott vidia vágóél • Hornyok kivitelezésére alkalmas • Asztali marókon, formázó marókon, stb. használható • Egyedi igény esetén a marók gyorsacél (HS) vágóélekkel is szállíthatók

Body in hardened and tempered steel • 12 HW brazed cutting edges • Suitable for the execution of joints • Can be used on toupie, moulding machines, etc. • On request the cutters can be supplied with HS cutting edges

**Z=12**

● = Készleten van ■ = Szállítási idő 20 munkanap ▲ = Rendelésre

D	S	F	Cikkszám
140	4	30	▲ F112M1400412
140	6	30	▲ F112M1400612
140	8	30	▲ F112M1400812
140	10	30	▲ F112M1401012
140	12	30	▲ F112M1401212
140	14	30	▲ F112M1401412
160	4	30	▲ F112M1600412
160	6	30	▲ F112M1600612
160	8	30	▲ F112M1600812
160	10	30	▲ F112M1601012
160	12	30	▲ F112M1601212
160	14	30	▲ F112M1601412
200	4	40	▲ F112M2000412
200	6	40	▲ F112M2000612
200	8	40	▲ F112M2000812
200	10	40	▲ F112M2001012
200	12	40	▲ F112M2001212
200	14	40	▲ F112M2001412
Spec. HW			F112M99
Spec. HS			F112S99

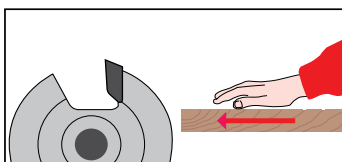
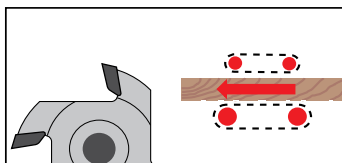
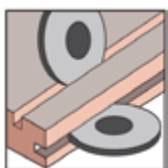
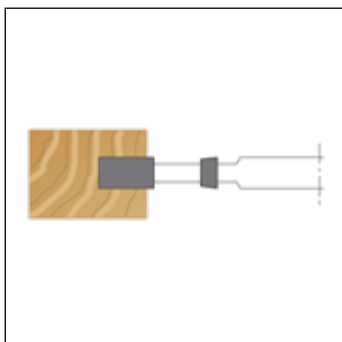
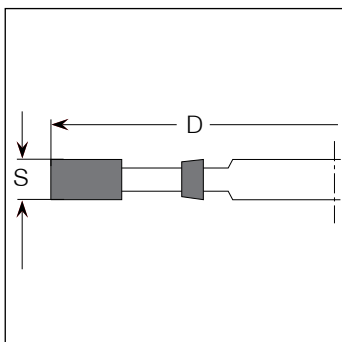

TAGLIO / SEZIONATURA  
SAWING

DIAMANTE  
DIAMOND

FRESATURA  
CUTTING

PANTOGRAFATURA  
ROUTING

FORATURA  
BORING

MANDRINI / ATTACCHI  
CHUCKS & CLAMPING SYSTEM

RICAMBI E LAVORAZIONI SUPP.  
SPARE PARTS & ADD. WORKING



Távtartókkal állítható horonymarók elővágóval



Verstellnutfräser mit Vorschneider und Distanzringe



Porte-outils à rainner extensible avec bagues de réglage HW



Пазовые фрезы регулируемые с подрезными ножами HW

**F120**

**HW** Állítható horonymarók elővágóval

TAGLIO / SEZIONATURA  
SAWING

DIAMANTE  
DIAMOND

FRESATURA  
CUTTING

PANTOGRAFATURA  
ROUTING

FORATURA  
BORING

MANDRINI / ATTACCHI  
CHUCKS & CLAMPING SYSTEM

RICAMBI E LAVORAZIONI SUPP.  
SPARE PARTS & ADD. WORKING

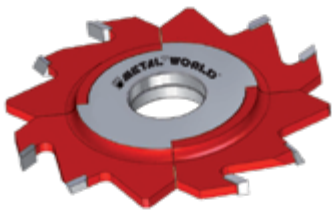
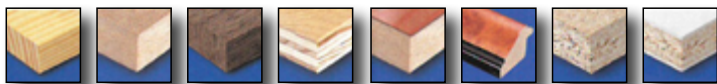

Edzett acélból készült test • 4 vágó + 4 elővágó beforrasztott vidia él • Kiváló felületminőség • Távtartókkal állítható, ezért különböző szélességű hornyok kivitelezésére alkalmas • Asztali marókon, formázó marókon, stb. használható • Egyedi igény esetén a marók gyorsacél (HS) vágóélekkel is szállíthatók

Body in hardened and tempered steel • 4 cutting edges + 4 spurs brazed in HW • Excellent finish • Suitable for running grooves of different thickness using spacers • Can be used on toupie, moulding machines, etc. • On request the cutters can be supplied with HS cutting edges

**Z=4 V=4**

● = Készleten van

■ = Szállítási idő 20 munkanap

△ = Rendelésre

D	S	F	Cikkszám
150	4÷7,5	30	△ F120M15004AA
150	7,5÷14,5	30	△ F120M15007AA
150	10÷19	30	△ F120M15010AA
Spec. HW			F120M99
Spec. HS			F120S99

TÁVTARTÓGYÜRÜ KÉSZLET

S	Cikkszám
4÷7,5	△ KAF120M0407A
7,5÷14,5	△ KAF120M0714A
10÷19	△ KAF120M1019A

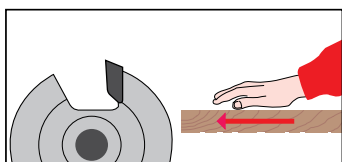
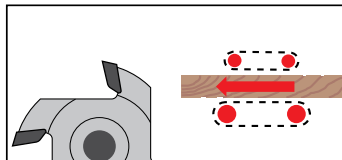
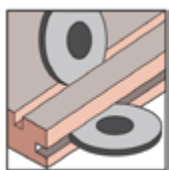
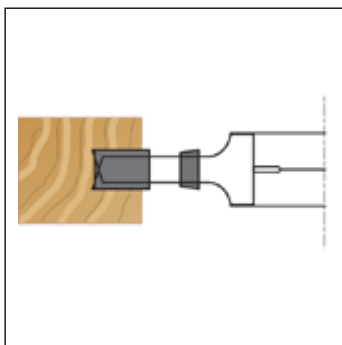
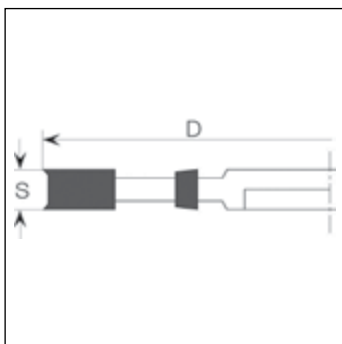

Gyűrűs anyával  
állítható horonymarók  
elővágóval

Verstellnutfräser  
mit Vorschneider  
(Gewindebuchse)

Porte-outils à rainier  
extensible avec douille  
de réglage HW

Пазовые фрезы регулируемые  
градуированным кольцом HW



**F130**

**HW** Állítható horonymarók elővágóval

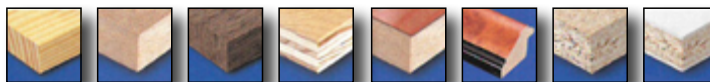

Edzett acélból készült test • 4 vágó + 4 elővágó beforrasztott vidia él • Kiváló felületminőség • Különböző szélességű horonyok kivitelezésére alkalmas • Állítása gyűrűs anyával történik • Asztali marókon, formázó marókon, stb. használható • Egyedi igény esetén a marók gyorsacél (HS) vágóélekkel is szállíthatók

Body in hardened and tempered steel • 4 cutting edges + 4 spurs brazed in HW • Excellent finish • Suitable for running grooves of different thickness using ring nut • Can be used on toupie, moulding machines, etc. • On request the cutters can be supplied with HS cutting edges

**Z=4 V=4**

● = Készleten van ■ = Szállítási idő 20 munkanap ▲ = Rendelésre

D	S	F	Cikkszám
150	4÷7,5	30	▲ F130M15004AR
150	7,5÷14,5	30	▲ F130M15007AR
150	10÷19	30	▲ F130M15010AR
Spec. HW			F130M99
Spec. HS			F130S99

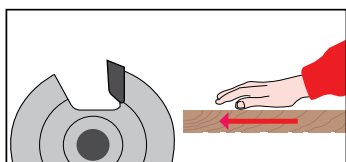
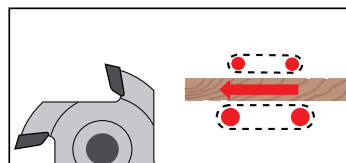
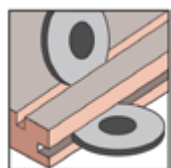
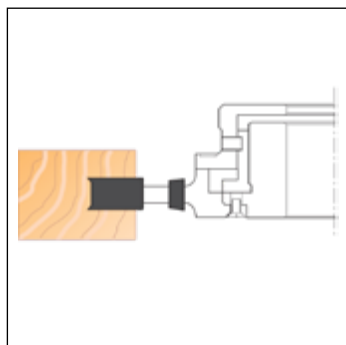
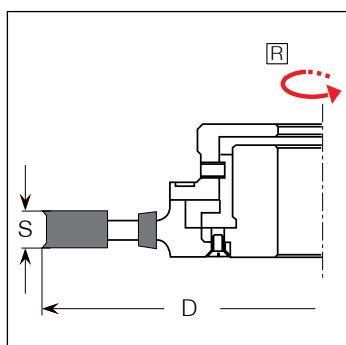

TAGLIO / SEZIONATURA  
SAWING

DIAMANTE  
DIAMOND

FRESATURA  
CUTTING

PANTOGRAFATURA  
ROUTING

FORATURA  
BORING

MANDRINI / ATTACCHI  
CHUCKS & CLAMPING SYSTEM

RICAMBI E LAVORAZIONI SUPP.  
SPARE PARTS & ADD. WORKING



Távtartókkal állítható horonymarók elővágóval



Verstellnutfräser mit Vorschneider mit Distanzringe



Fraises à rainier extensible avec bagues de réglage avec araseurs



Пазовые фрезы регулируемые с подрезными ножами

**F140**

**HW** Állítható horonymarók elővágóval

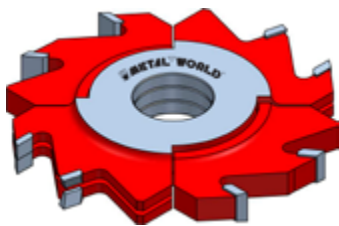

Edzett acélból készült test • 4 vágó + 4 elővágó beforrasztott vidia él • Kiváló felületminőség • Távtartókkal állítható, ezért különböző szélességű hornyok kivitelezésére alkalmas • Asztali marókon, formázó marókon, végprofilozó gépeken, stb. használható • Egyedi igény esetén a marók gyorsacél (HS) vágóélekkel is szállíthatók

Body in hardened and tempered steel • 4+4 cutting edges + 4 spurs brazed in HW • Excellent finish • Suitable for running grooves of different thickness using spacers • Can be used on table, moulding machines, double end tenoner, etc. • On request the cutters can be supplied with HS cutting edges

**Z=4+4 V=4**

● = Készleten van

■ = Szállítási idő 20 munkanap

△ = Rendelésre

D	S	F	Cikkszám
150	7,5÷28	30	△ F140M15007AA
Spec. HW			F140M99
Spec. HS			F140S99

TÁVTARTÓGYÜRÜ KÉSZLET

S	Cikkszám
15÷28	△ KAF140M1528A

TAGLIO / SEZIONATURA  
SAWING

DIAMANTE  
DIAMOND

FRESATURA  
CUTTING

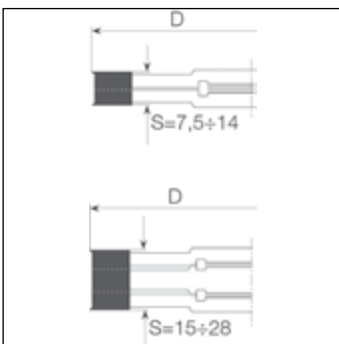

PANTOGRAFATURA  
ROUTING

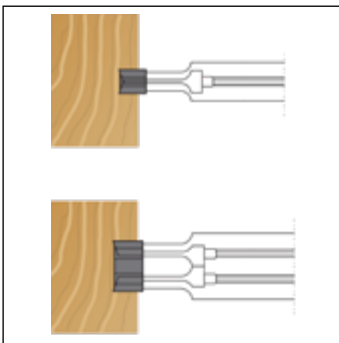

FORATURA  
BORING

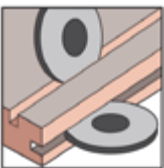

MANDRINI / ATTACCHI  
CHUCKS & CLAMPING SYSTEM

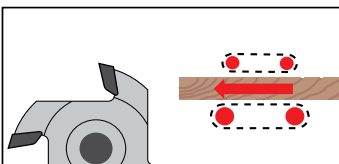

RICAMBI E LAVORAZIONI SUPP.  
SPARE PARTS & ADD. WORKING

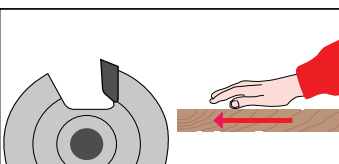

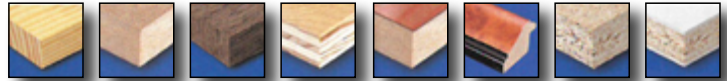
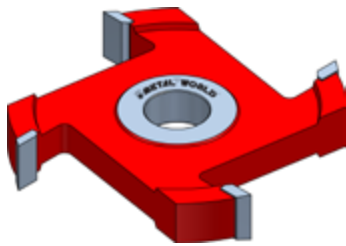
**F160****HW Fügemarók**

Edzett acélból készült test • 4 beforrasztott vídia vágóél • Háromféle kivitelben kapható: tengelyferdeség nélkül, pozitív vagy negatív tengelyferdeséggel • Asztali marókon, formázó marókon, stb. használható • Egyedi igény esetén a marók gyorsacél (HS) vágóélékkel is szállíthatók

Body in hardened and tempered steel • 4 HW brazed cutting edges • Perform in three models: without , with negative or positive axial • Can be used on toupie, moulding machines, etc. • On request the cutters can be supplied with HS cutting edges

**Z=4**

● = Készleten van

■ = Szállítási idő 20 munkanap

△ = Rendelésre

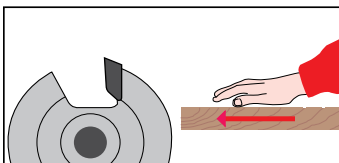
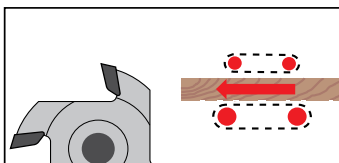
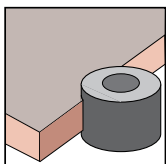
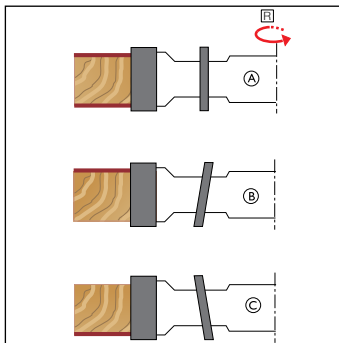
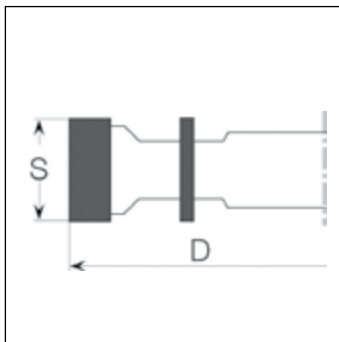

D	S	F	Cikkszám
120	20	30	△ F160M12020AA
120	25	30	△ F160M12025AA
120	30	30	△ F160M12030AA
120	35	30	△ F160M12035AA
120	40	30	△ F160M12040AA
120	50	30	△ F160M12050AA
120	60	30	△ F160M12060AA
120	70	30	△ F160M12070AA
120	80	30	△ F160M12080AA
160	20	30	△ F160M16020AA
160	25	30	△ F160M16025AA
160	30	30	△ F160M16030AA
160	35	30	△ F160M16035AA
160	40	30	△ F160M16040AA
160	50	30	△ F160M16050AA
160	60	30	△ F160M16060AA
160	70	30	△ F160M16070AA
160	80	30	△ F160M16080AA
200	20	40	△ F160M20020AA
200	25	40	△ F160M20025AA
200	30	40	△ F160M20030AA
200	35	40	△ F160M20035AA
200	40	40	△ F160M20040AA
200	50	40	△ F160M20050AA
200	60	40	△ F160M20060AA
200	70	40	△ F160M20070AA
200	80	40	△ F160M20080AA
Spec. HW			F160M99
Spec. HS			F160S99

\* Megrendeléskor meg kell adni a modelltypust (A, B vagy C) és a megmunkálandó anyag fajtáját  
\* At the order specify the Mod. A/B/C and the material to workout

Falcmárók egyik oldalon elővágóval

Falzfräser mit Vorschneider einseitig

Fraises à feuillurer simple verso

Фрезы для четверти

**F180**

**HW Falcmárók elővágóval**

TAGLIO / SEZIONATURA  
SAWING

DIAMANTE  
DIAMOND

FRESATURA  
CUTTING

PANTOGRAFATURA  
ROUTING

FORATURA  
BORING

MANDRINI / ATTACCHI  
CHUCKS & CLAMPING SYSTEM

RICAMBI E LAVORAZIONI SUPP.  
SPARE PARTS & ADD. WORKING

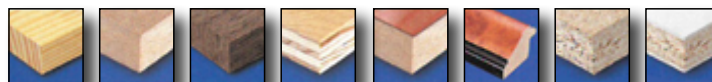
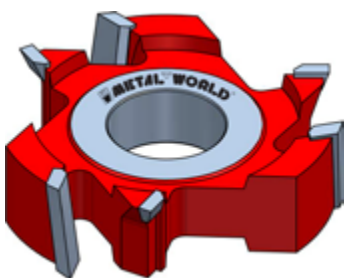

Edzett acélból készült test • 3 vágó + 3 elővágó beforrasztott vidia él • Jó felületminőség • Különböző szélességű falcok kivitelezésére ajánlott • Tömör fa megmunkálására alkalmas • Asztali marókra, formázó marókra, stb. szerelhető • Megrendeléskor meg kell adni a modell típust (A vagy B) és a megmunkálandó anyag fajtáját • Egyedi igény esetén a marók gyorsacél (HS) vágó-és elővágó éllel is szállíthatók

Body in hardened and tempered steel • 3 cutting edges + 3 spurs brazed in HW • Good finish • Indicated for running rebating different thickness • Suitable for working solid wood • Can be used on toupie, moulding machines, etc. • At the order specify the model A/B and the material to workout • On request the cutters can be supplied with HS cutting edges and spurs

**Z=3 V=3**

● = Készleten van ■ = Szállítási idő 20 munkanap ▲ = Rendelésre

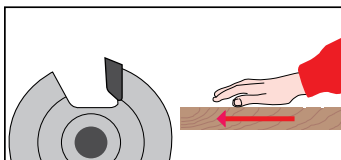
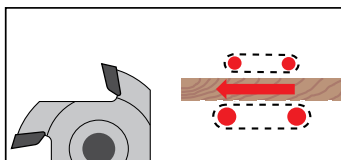
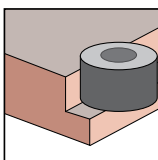
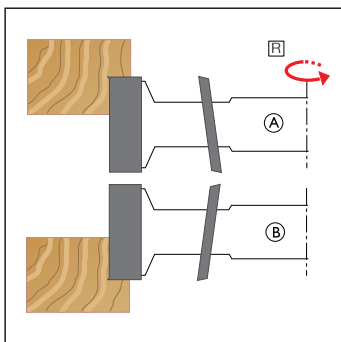
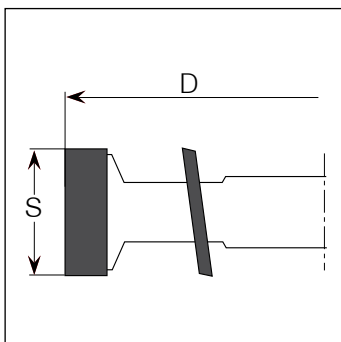

D	S	F	Cikkszám
120	15	30	▲ F180M12015AA
120	20	30	▲ F180M12020AA
120	25	30	▲ F180M12025AA
120	30	30	▲ F180M12030AA
120	35	30	▲ F180M12035AA
120	40	30	▲ F180M12040AA
120	50	30	▲ F180M12050AA
120	60	30	▲ F180M12060AA
120	70	30	▲ F180M12070AA
120	80	30	▲ F180M12080AA
160	15	30	▲ F180M16015AA
160	20	30	▲ F180M16020AA
160	25	30	▲ F180M16025AA
160	30	30	▲ F180M16030AA
160	35	30	▲ F180M16035AA
160	40	30	▲ F180M16040AA
160	50	30	▲ F180M16050AA
160	60	30	▲ F180M16060AA
160	70	30	▲ F180M16070AA
160	80	30	▲ F180M16080AA
200	15	40	▲ F180M20015AA
200	20	40	▲ F180M20020AA
200	25	40	▲ F180M20025AA
200	30	40	▲ F180M20030AA
200	35	40	▲ F180M20035AA
200	40	40	▲ F180M20040AA
200	50	40	▲ F180M20050AA
200	60	40	▲ F180M20060AA
200	70	40	▲ F180M20070AA
200	80	40	▲ F180M20080AA

Spec. HW F180M99  
Spec. HS F180S99

Falcmárók mindkét oldalon elővágóval

Falzfräser mit Vorschneider beidseitig

Fraises à feullurer ci-dessus et ci-dessous HW

Фрезы для четверти

**F190**

**HW Falcmárók elővágóval**

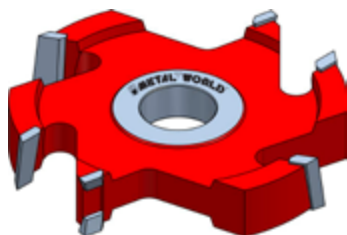
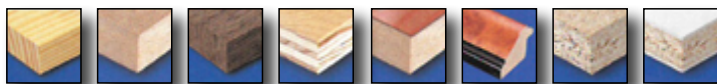

CÉdzett acélból készült test • 4 vágó + 4 elővágó beforrasztott vidia él • Jó felületminőség a vágó- és elővágó élek váltakozó tengelyferdesége miatt • Panelek tetején és alján falcok készítésére javasolt • Tomor fa megmunkálására alkalmas • Asztali marókra, formázó marókra, stb. szerelhető • Egyedi igény esetén a marók gyorsacél (HS) vágó- és elővágó élekkel is szállíthatók

Body in hardened and tempered steel • 4 cutting edges + 4 spurs brazed in HW • Good finish thanks to spurs and alternated axial cutting edges • Indicated for running rebating top and bottom of panels • Suitable for working solid wood • Can be used on toupie, moulding machines, etc. • At the order specify the model A/B and the material to workout • On request the cutters can be supplied with HS cutting edges and spurs

**Z=4 V=4**

● = Készleten van ■ = Szállítási idő 20 munkanap ▲ = Rendelésre

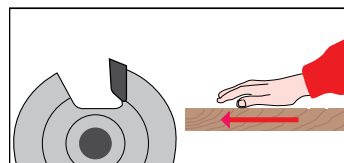
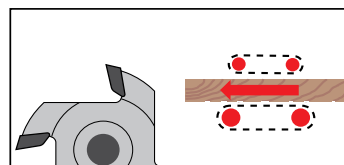
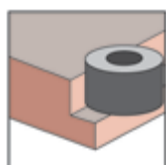
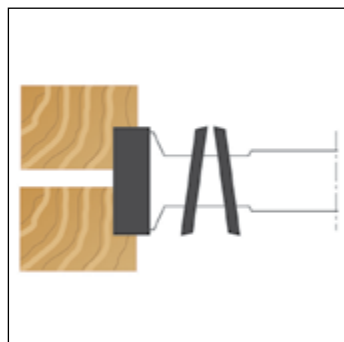
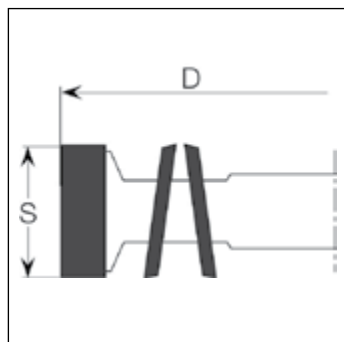

D	S	F	Cikkszám
120	20	30	▲ F190M12020AA
120	25	30	▲ F190M12025AA
120	30	30	▲ F190M12030AA
120	35	30	▲ F190M12035AA
120	40	30	▲ F190M12040AA
120	50	30	▲ F190M12050AA
120	60	30	▲ F190M12060AA
120	70	30	▲ F190M12070AA
120	80	30	▲ F190M12080AA
160	20	30	▲ F190M16020AA
160	25	30	▲ F190M16025AA
160	30	30	▲ F190M16030AA
160	35	30	▲ F190M16035AA
160	40	30	▲ F190M16040AA
160	50	30	▲ F190M16050AA
160	60	30	▲ F190M16060AA
160	70	30	▲ F190M16070AA
160	80	30	▲ F190M16080AA
200	20	40	▲ F190M20020AA
200	25	40	▲ F190M20025AA
200	30	40	▲ F190M20030AA
200	35	40	▲ F190M20035AA
200	40	40	▲ F190M20040AA
200	50	40	▲ F190M20050AA
200	60	40	▲ F190M20060AA
200	70	40	▲ F190M20070AA
200	80	40	▲ F190M20080AA
Spec. HW			F190M99
Spec. HS			F190S99

TAGLIO / SEZIONATURA  
SAWING

DIAMANTE  
DIAMOND

FRESATURA  
CUTTING

PANTOGRAFATURA  
ROUTING

FORATURA  
BORING

MANDRINI / ATTACCHI  
CHUCKS & CLAMPING SYSTEM

RICAMBI E LAVORAZIONI SUPP.  
SPARE PARTS & ADD. WORKING

Sokfogú marók

Mehrschneidiger-Fräskopf

Fraises à calibrer coupe  
hélicoïdale HW

Фуговальные фрезы

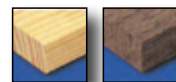
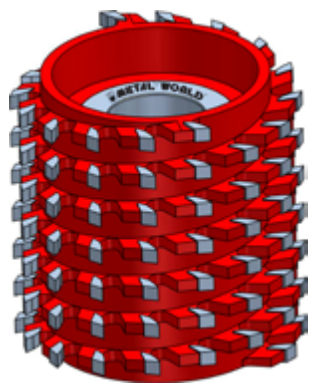
**F200****HW Sokfogú marófejek (kukoricamarók)**

Edzett acélból készült test • Beforrasztott vídía vágóélek • Olyan ívelt elemek kivágásra alkalmas, ahol nagy anyagmennyiséget kell leválasztani • A nagy spirális kivitel csökkenti az energiafelvételt és a zajt, és megnöveli a szerszám él(et)tartamát • Tömör fa és más hasonló anyagok megmunkálására ajánlott • Asztali marógépre, formázó marógépre szerelhető fel

Body in hardened and tempered steel • HW brazed cutting edges • Suitable for trimming curved elements and for high material removal • The large spiral execution reduces the electrical input and the noise and increases the tool life • Suitable for working solid wood and other materials • Can be used on toupie, moulding machines, etc.

● = Készleten van ■ = Szállítási idő 20 munkanap ▲ = Rendelésre

D	S	Div.	F	Cikkszám
120	60	10	40	▲ F200M1200610
120	80	10	40	▲ F200M1200810
120	100	10	40	▲ F200M1201010
120	120	10	40	▲ F200M1201210
120	140	10	40	▲ F200M1201410
120	160	10	40	▲ F200M1201610
120	180	10	40	▲ F200M1201810
140	60	10	40	▲ F200M1400610
140	80	10	40	▲ F200M1400810
140	100	10	40	▲ F200M1401010
140	120	10	40	▲ F200M1401210
140	140	10	40	▲ F200M1401410
140	160	10	40	▲ F200M1401610
140	180	10	40	▲ F200M1401810
120	60	12	40	▲ F200M1200612
120	80	12	40	▲ F200M1200812
120	100	12	40	▲ F200M1201012
120	120	12	40	▲ F200M1201212
120	140	12	40	▲ F200M1201412
120	160	12	40	▲ F200M1201612
120	180	12	40	▲ F200M1201812
120	230	12	40	▲ F200M1202312
125	60	12	40	▲ F200M1250612
125	80	12	40	▲ F200M1250812
125	100	12	40	▲ F200M1251012
125	120	12	40	▲ F200M1251212
125	140	12	40	▲ F200M1251412
125	160	12	40	▲ F200M1251612
125	180	12	40	▲ F200M1251812
125	200	12	40	▲ F200M1252012
125	230	12	40	▲ F200M1252312
125	240	12	40	▲ F200M1252412

Spec. HW F200M99  
Spec. HS F200S99

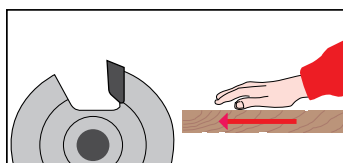
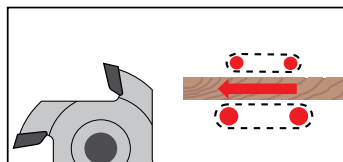
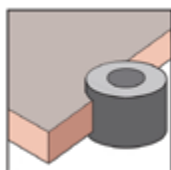
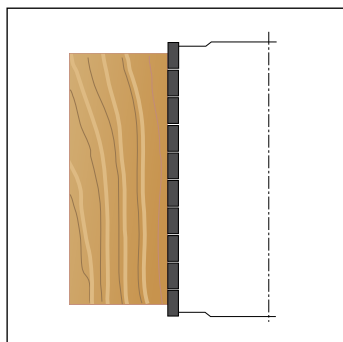
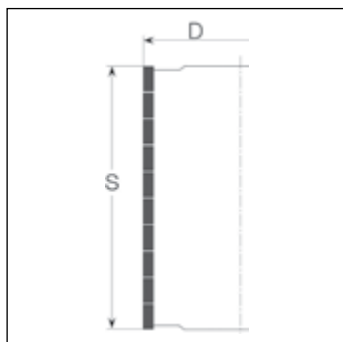
TAGLIO / SEZIONATURA  
SAWINGDIAMANTE  
DIAMONDFRESATURA  
CUTTINGPANTOGRAFATURA  
ROUTINGFORATURA  
BORINGMANDRINI / ATTACCHI  
CHUCKS & CLAMPING SYSTEMRICAMBI E LAVORAZIONI SUPP.  
SPARE PARTS & ADD. WORKING

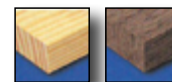
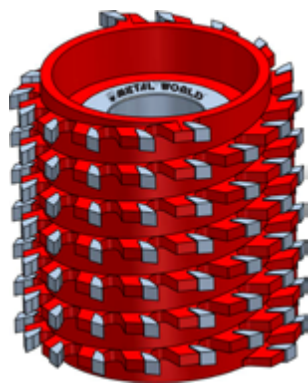

**F200****HW Sokfogú marófejek (kukoricamarók)**

Edzett acélból készült test • Beforrasztott vídia vágóélek • Olyan ívelt elemek kivágásra alkalmas, ahol nagy anyagmennyiséget kell leválasztani • A nagy spirális kivitel csökkenti az energiafelvételt és a zajt, és megnöveli a szerszám él(et)tartamát • Tömör fa és más hasonló anyagok megmunkálására ajánlott • Asztali marógépre, formázó marógépre szerelhető fel

Body in hardened and tempered steel • HW brazed cutting edges • Suitable for trimming curved elements and for high material removal • The large spiral execution reduces the electrical input and the noise and increases the tool life • Suitable for working solid wood and other materials • Can be used on toupie, moulding machines, etc.

● = Készleten van ■ = Szállítási idő 20 munkanap ▲ = Rendelésre

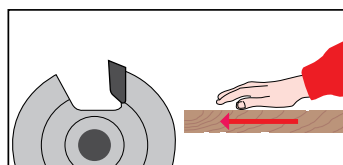
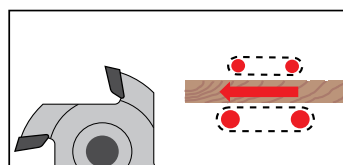
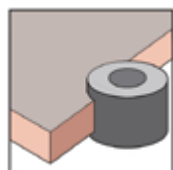
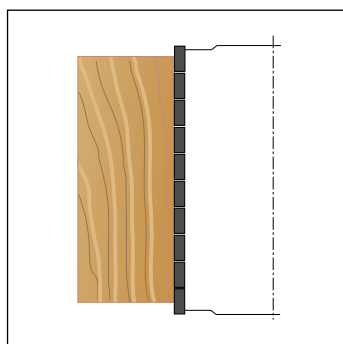
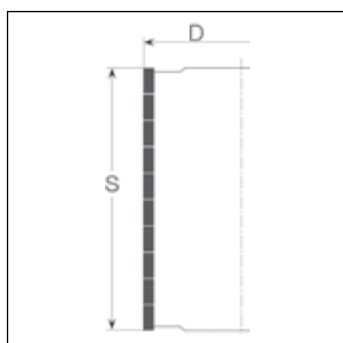

D	S	Div.	F	Cikkszám
140	60	12	40	▲ F200M1400612
140	80	12	40	▲ F200M1400812
140	100	12	40	▲ F200M1401012
140	120	12	40	▲ F200M1401212
140	140	12	40	▲ F200M1401412
140	160	12	40	▲ F200M1401612
140	180	12	40	▲ F200M1401812
140	200	12	40	▲ F200M1402012
140	230	12	40	▲ F200M1402312
140	240	12	40	▲ F200M1402412
120	60	16*	40	▲ F200M1200616
120	80	16*	40	▲ F200M1200816
120	100	16*	40	▲ F200M1201016
120	120	16*	40	▲ F200M1201216
120	140	16*	40	▲ F200M1201416
120	160	16*	40	▲ F200M1201616
120	180	16*	40	▲ F200M1201816
120	230	16*	40	▲ F200M1202316
125	60	16*	40	▲ F200M1250616
125	80	16*	40	▲ F200M1250816
125	100	16*	40	▲ F200M1251016
125	120	16*	40	▲ F200M1251216
125	140	16*	40	▲ F200M1251416
125	160	16*	40	▲ F200M1251616
125	180	16*	40	▲ F200M1251816
125	200	16*	40	▲ F200M1252016
125	230	16*	40	▲ F200M1252316
140	60	16*	40	▲ F200M1400616
140	80	16*	40	▲ F200M1400816
140	100	16*	40	▲ F200M1401016
140	120	16*	40	▲ F200M1401216
140	140	16*	40	▲ F200M1401416
140	160	16*	40	▲ F200M1401616
140	180	16*	40	▲ F200M1401816
140	230	16*	40	▲ F200M1402316
Spec. HW				F200M99
Spec. HS				F200S99

\* Igény esetén Z 1 és forgácstörő

\* On request execution Z 1 and chipbreaker

TAGLIO / SEZIONATURA  
SAWINGDIAMANTE  
DIAMONDFRESATURA  
CUTTINGPANTOGRAFATURA  
ROUTINGFORATURA  
BORINGMANDRINI / ATTACCHI  
CHUCKS & CLAMPING SYSTEMRICAMBI E LAVORAZIONI SUPP.  
SPARE PARTS & ADD. WORKING

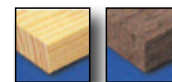
**F210****HW Ferde leélező marók**

Edzett acélból készült test • 4 beforrasztott vídiavágóél • Állandó szögű (1°-45°) élettörések kivitelezésére ajánlott • Jó felületminőség a különféle fafajtákon • Asztali marókra, formázó marókra, stb. szerelhető fel • Egyedi igény esetén a marók gyorsacél (HS) vágóélekkel is szállíthatók

Body in hardened and tempered steel • 4 HW brazed cutting edges • Indicated for making bevel with fix angle (1°-45°) • Good finish on different kind of wood • Can be used on toupie, moulding machines, etc. • On request the cutters can be supplied with HS cutting edges

**Z=4**

● = Készleten van   ■ = Szállítási idő 20 munkanap   △ = Rendelésre

D	S	β max	FA	A tip. cikkszám	B. tip. cikkszám
120	20	45°	30	△ F210M12020AX	△ F210M12020BX
120	25	38°	30	△ F210M12025AX	△ F210M12025BX
120	30	33°	30	△ F210M12030AX	△ F210M12030BX
120	35	29°	30	△ F210M12035AX	△ F210M12035BX
120	40	26°	30	△ F210M12040AX	△ F210M12040BX
120	50	21°	30	△ F210M12050AX	△ F210M12050BX
160	20	45°	30	△ F210M16020AX	△ F210M16020BX
160	25	45°	30	△ F210M16025AX	△ F210M16025BX
160	30	45°	30	△ F210M16030AX	△ F210M16030BX
160	35	45°	30	△ F210M16035AX	△ F210M16035BX
160	40	41°	30	△ F210M16040AX	△ F210M16040BX
160	50	35°	30	△ F210M16050AX	△ F210M16050BX
160	60	30°	30	△ F210M16060AX	△ F210M16060BX
160	70	26°	30	△ F210M16070AX	△ F210M16070BX
200	20	45°	40	△ F210M20020AX	△ F210M20020BX
200	25	45°	40	△ F210M20025AX	△ F210M20025BX
200	30	45°	40	△ F210M20030AX	△ F210M20030BX
200	35	45°	40	△ F210M20035AX	△ F210M20035BX
200	40	45°	40	△ F210M20040AX	△ F210M20040BX
200	50	45°	40	△ F210M20050AX	△ F210M20050BX
200	60	39°	40	△ F210M20060AX	△ F210M20060BX
200	70	35°	40	△ F210M20070AX	△ F210M20070BX
200	80	32°	40	△ F210M20080AX	△ F210M20080BX
Spec. HW					F210M99
Spec. HS					F210S99

\* Megrendeléskor meg kell adni a megmunkálandó anyag fajtáját  
\* At the order specify the material to workout

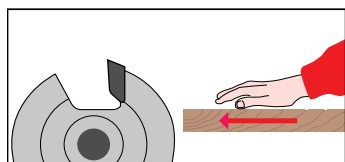
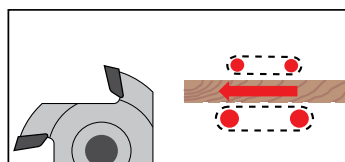
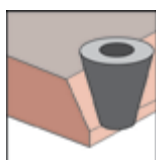
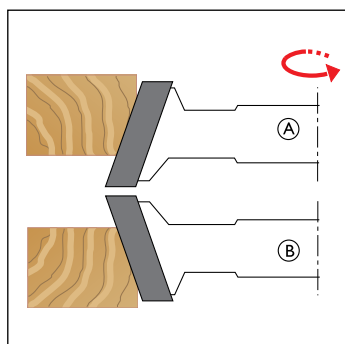
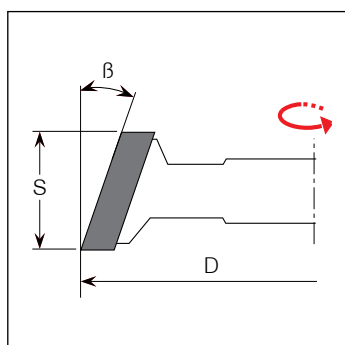



# F218

## HW Bútorajtó marók



Edzett acélból készült test • Beforrasztott vidia vágóél • Konyhabútor ajtó profil, kontraprofil és középrész elkészítéséhez ajánlott • Alkalmas 20 mm vastag standard ajtóprofil, kontraprofil és középrész előállítására • Asztali marógépre szerelhető

Body in hardened and tempered steel • HW brazed cutting edges • Indicated for the execution of profiles, counter profiles and central panels for cabinet • Suitable for creating standard profiles on central panels for cabinet with thickness of 20 mm • Can be used on toupie machines

**Z=2+2+2+2**

● = Készleten van   ■ = Szállítási idő 20 munkanap   △ = Rendelésre

D	F	Cikkszám
180	40	△ F218M18050AA
Spec. HW		F218M99
Spec. HS		F218S99

PÓTALKATRÉSZEK

Megnevezés	Méret	Cikkszám
Felső maró	180X26	■ F218M18026A1
Középső maró	180X25	■ F218M18025A2
Alsó maró	180X5	■ F218M18005A3

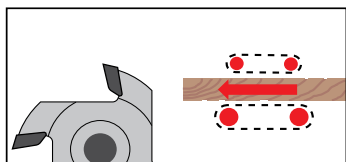
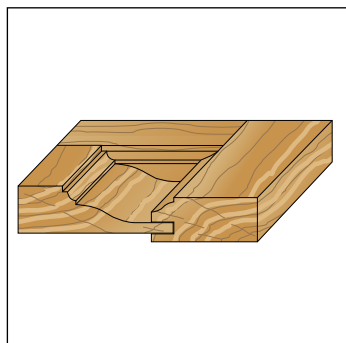
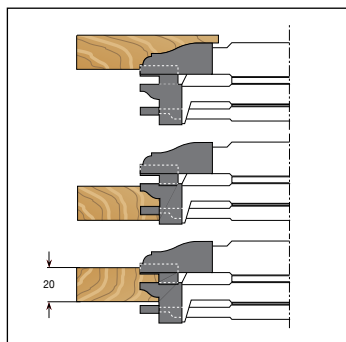
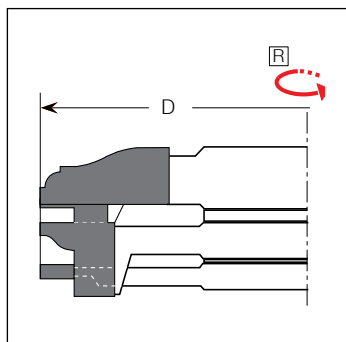

TAGLIO / SEZIONATURA  
SAWING

DIAMANTE  
DIAMOND

FRESATURA  
CUTTING

PANTOGRAFATURA  
ROUTING

FORATURA  
BORING

MANDRINI / ATTACCHI  
CHUCKS & CLAMPING SYSTEM

RICAMBI E LAVORAZIONI SUPP.  
SPARE PARTS & ADD. WORKING

## F220

## HW Panel-oldalsáv marók

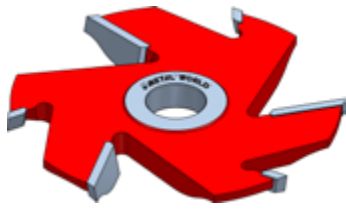
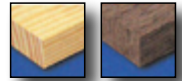

Edzett acélból készült test • Beforrasztott vidia vágóél • Konyhabútor és más ajtó középrész elkészítéséhez ajánlott  
• Asztali marókon, formázó marókon, végprofilozó gépeken, stb. használható

Body in hardened and tempered steel • HW brazed cutting edges • Indicated for the execution of central panels for cabinet, door panels, etc. • Can be used on toupie, moulder machines and double end tenoner machines, etc.

● = Készleten van ■ = Szállítási idő 20 munkanap ▲ = Rendelésre

D	S	F	Z	A tip. cikkszám	B tip. cikkszám	C tip. cikkszám
200	20	40	3	▲ F220M20003AA	▲ F220M20003BA	▲ F220M20003CA
200	20	40	4	▲ F220M20004AA	▲ F220M20004BA	▲ F220M20004CA
200	20	40	6	▲ F220M20006AA	▲ F220M20006BA	▲ F220M20006CA
200	20	40	3+3	▲ F220M20033AA	▲ F220M20033BA	▲ F220M20033CA
200	20	40	4+4	▲ F220M20044AA	▲ F220M20044BA	▲ F220M20044CA

Spec.

F220M99

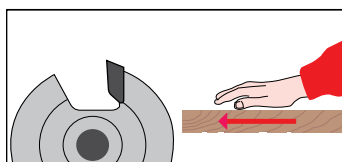
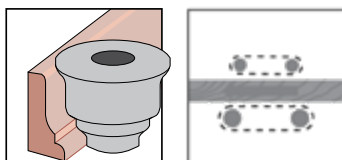
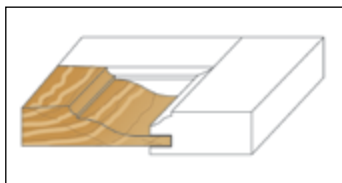
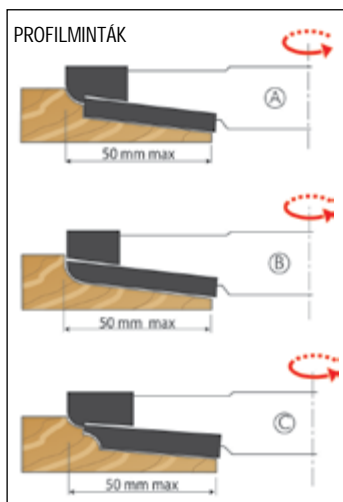
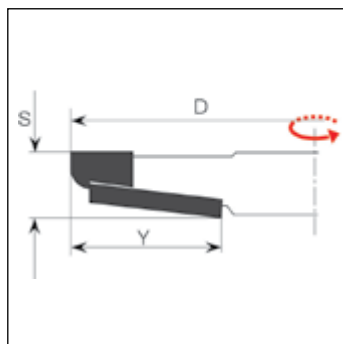

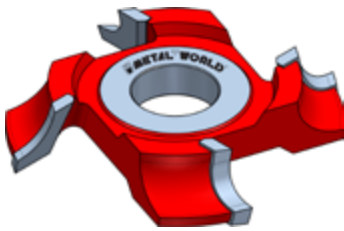
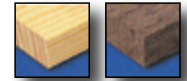
**F230****HW** Negyedkörív marók

Edzett acélból készült test • 4 beforrasztott vidia vágóél • Éleken rádiuszos profilok kivitelezésére javasolt • Asztali marókon, formázó marókon, végprofilozó gépeken, stb. használható • Egyedi igény esetén a marók gyorsacél (HS) vágóélekkel is szállíthatók

Body in hardened and tempered steel • 4 HW brazed cutting edges • Indicated for the execution of radius profiles on edges • Can be used on toupie, moulder machines and double end tenoner machines, etc. • On request the cutters can be supplied with HS cutting edges

**Z=4**

● = Készleten van

■ = Szállítási idő 20 munkanap

△ = Rendelésre

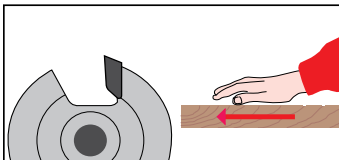
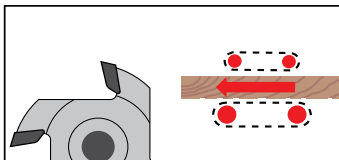
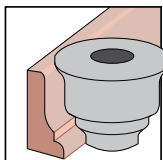
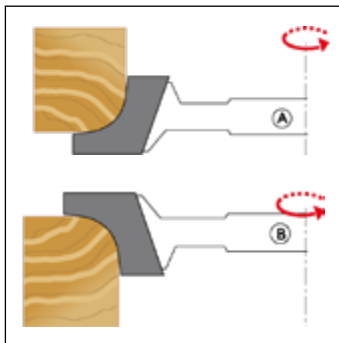
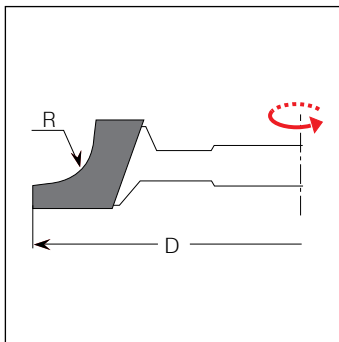

D	R	F	A tip. cikkszám	B tip. cikkszám
120	5	30	△ F230M12005AA	△ F230M12005BA
120	10	30	△ F230M12010AA	△ F230M12010BA
120	15	30	△ F230M12015AA	△ F230M12015BA
120	20	30	△ F230M12020AA	△ F230M12020BA
140	5	30	△ F230M14005AA	△ F230M14005BA
140	10	30	△ F230M14010AA	△ F230M14010BA
140	15	30	△ F230M14015AA	△ F230M14015BA
140	20	30	△ F230M14020AA	△ F230M14020BA
140	25	30	△ F230M14025AA	△ F230M14025BA
160	5	30	△ F230M16005AA	△ F230M16005BA
160	10	30	△ F230M16010AA	△ F230M16010BA
160	15	30	△ F230M16015AA	△ F230M16015BA
160	20	30	△ F230M16020AA	△ F230M16020BA
160	25	30	△ F230M16025AA	△ F230M16025BA
160	30	30	△ F230M16030AA	△ F230M16030BA
Spec. HW			F230M99	F230M99
Spec. HS			F230S99	F230S99

## F240

## HW Félkörív marók

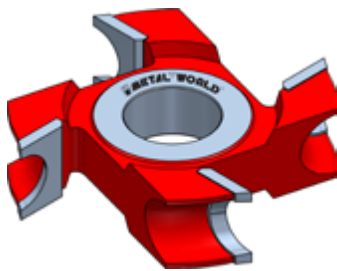
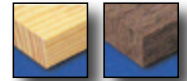

Edzett acélból készült test • 4 beforrasztott vídiá vágóél • Félkörívek és éleken rádiuszos profilok kivitelezésére javasolt  
• Asztali marókon, formázó marókon, stb. használható • Egyedi igény esetén a marók gyorsacél (HS) vágóélekkel is szállíthatók

Body in hardened and tempered steel • 4 HW brazed cutting edges • Indicated for the execution of half-round and radius profiles on edges • Can be used on toupie, moulder machines • On request the cutters can be supplied with HS cutting edges

Z=4

● = Készleten van

■ = Szállítási idő 20 munkanap

△ = Rendelésre

D	R	FC	Cikkszám
120	5	30	△ F240M12005AA
120	10	30	△ F240M12010AA
120	15	30	△ F240M12015AA
120	20	30	△ F240M12020AA
140	5	30	△ F240M14005AA
140	10	30	△ F240M14010AA
140	15	30	△ F240M14015AA
140	20	30	△ F240M14020AA
140	25	30	△ F240M14025AA
160	5	30	△ F240M16005AA
160	10	30	△ F240M16010AA
160	15	30	△ F240M16015AA
160	20	30	△ F240M16020AA
160	25	30	△ F240M16025AA
160	30	30	△ F240M16030AA
Spec. HW			F240M99
Spec. HS			F240S99

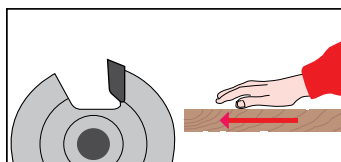
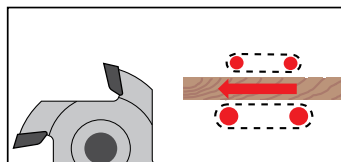
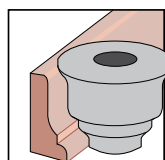
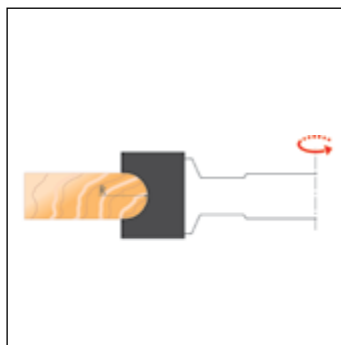
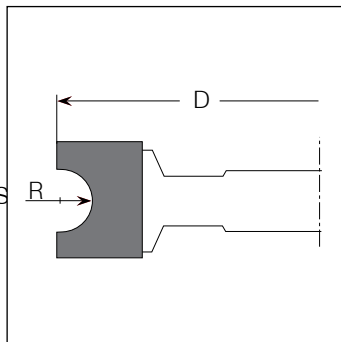



**F250** **HW** Köríves marók

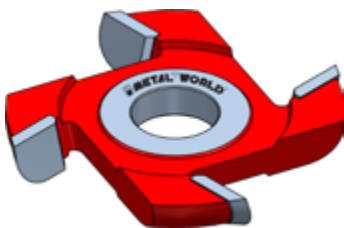
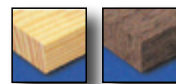

Edzett acélból készült test • 4 beforrasztott vídiá vágóél • Homorú negyedköríves kivitelezésére javasolt • Más profilozó szerszámokkal összekapcsolható • Asztali marókon, formázó marókon, stb. használható • Egyedi igény esetén a marók gyorsacél (HS) vágóélekkel is szállíthatók

Body in hardened and tempered steel • 4 HW brazed cutting edges • Indicated for the execution of concave quarter-round • To be coupled with other profiled tools • Can be used on toupie, moulder machines • On request the cutters can be supplied with HS cutting edges

**Z=4**

● = Készleten van ■ = Szállítási idő 20 munkanap ▲ = Rendelésre

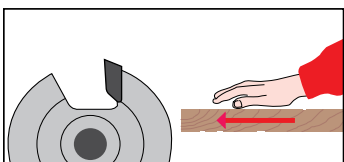
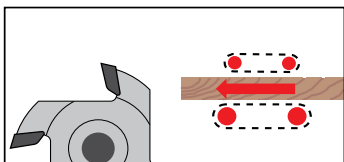
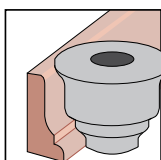
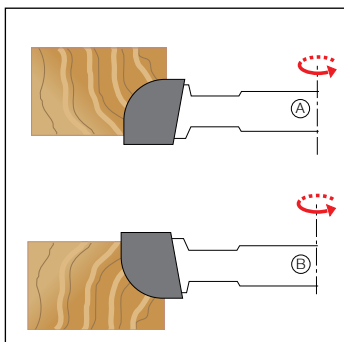
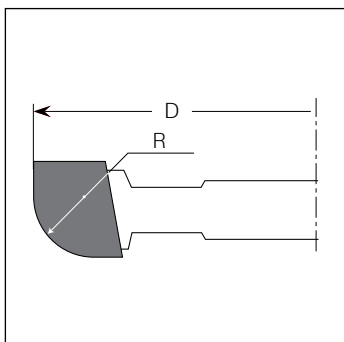

D	R	F	A tip. cikkszám	B tip. cikkszám
120	5	30	▲ F250M12005AA	▲ F250M12005BA
120	10	30	▲ F250M12010AA	▲ F250M12010BA
120	15	30	▲ F250M12015AA	▲ F250M12015BA
120	20	30	▲ F250M12020AA	▲ F250M12020BA
140	5	30	▲ F250M14005AA	▲ F250M14005BA
140	10	30	▲ F250M14010AA	▲ F250M14010BA
140	15	30	▲ F250M14015AA	▲ F250M14015BA
140	20	30	▲ F250M14020AA	▲ F250M14020BA
140	25	30	▲ F250M14025AA	▲ F250M14025BA
160	5	30	▲ F250M16005AA	▲ F250M16005BA
160	10	30	▲ F250M16010AA	▲ F250M16010BA
160	15	30	▲ F250M16015AA	▲ F250M16015BA
160	20	30	▲ F250M16020AA	▲ F250M16020BA
160	25	30	▲ F250M16025AA	▲ F250M16025BA
160	30	30	▲ F250M16030AA	▲ F250M16030BA
Spec. HW				F250M99
Spec. HS				F250S99

TAGLIO / SEZIONATURA  
SAWING

DIAMANTE  
DIAMOND

FRESATURA  
CUTTING

PANTOGRAFATURA  
ROUTING

FORATURA  
BORING

MANDRINI / ATTACCHI  
CHUCKS & CLAMPING SYSTEM

RICAMBI E LAVORAZIONI SUPP.  
SPARE PARTS & ADD. WORKING

Félkörmaró

Kehlfräser

Fraises à gorge

Фрезы радиусные

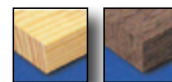
**F260****HW** Homorú rádiusmaró

Edzett acélból készült test • 4 beforrasztott vídia vágóél • Homorú félkörívek (pl. íves hornyok) kivitelezésére javasolt • Más profilozó szerszámokkal összekapcsolható • Asztali marókon, formázó marókon, stb. használható • Egyedi igény esetén a marók gyorsacél (HS) vágóélékkel is szállíthatók

Body in hardened and tempered steel • 4 HW brazed cutting edges • Indicated for the execution of concave half-round, i.e. round grooves • To be coupled with other profiled tools • Can be used on toupie, moulder machines • On request the cutters can be supplied with HS cutting edges

**Z=4**

● = Készleten van

■ = Szállítási idő 20 munkanap

△ = Rendelésre

D	R	F	Cikkszám
120	5	30	△ F260M12005AA
120	10	30	△ F260M12010AA
120	15	30	△ F260M12015AA
120	20	30	△ F260M12020AA
140	5	30	△ F260M14005AA
140	10	30	△ F260M14010AA
140	15	30	△ F260M14015AA
140	20	30	△ F260M14020AA
140	25	30	△ F260M14025AA
160	5	30	△ F260M16005AA
160	10	30	△ F260M16010AA
160	15	30	△ F260M16015AA
160	20	30	△ F260M16020AA
160	25	30	△ F260M16025AA
160	30	30	△ F260M16030AA
Spec. HW			F260M99
Spec. HS			F260S99

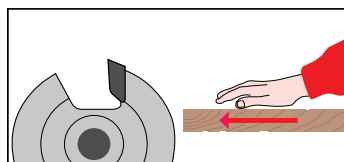
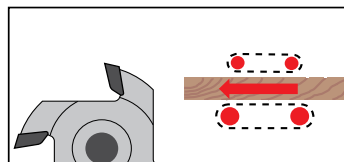
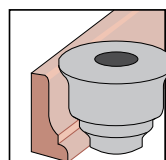
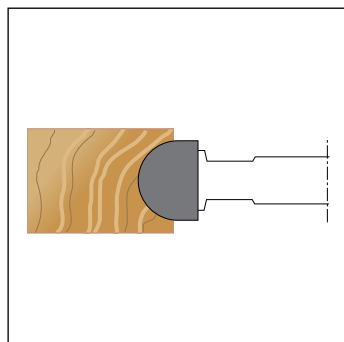
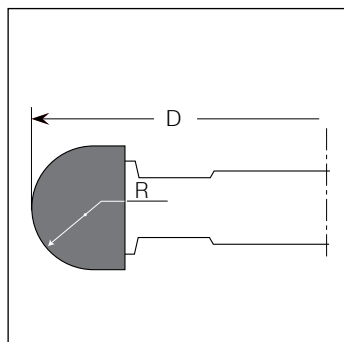
TAGLIO / SEZIONATURA  
SAWINGDIAMANTE  
DIAMONDFRESATURA  
CUTTINGPANTOGRAFATURA  
ROUTINGFORATURA  
BORINGMANDRINI / ATTACCHI  
CHUCKS & CLAMPING SYSTEMRICAMBI E LAVORAZIONI SUPP.  
SPARE PARTS & ADD. WORKING





# F265

## HW Lekerekítő és élettörő marókészlet

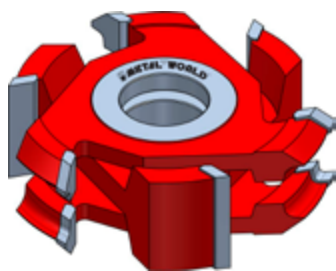
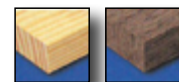

Edzett acélból készült test • Mindegyik maró 3 beforrasztott vidia vágóélű • Élek lekerekítésére és letörésére javasolt  
 • Asztali marókon, formázó marókon, stb. használható • Egyedi igény esetén a marók gyorsacél (HS) vágóélekkel is szállíthatók

Body in hardened and tempered steel • 3 HW brazed cutting edges for each tool • Indicated for rounding and chamfering • Can be used on toupie, moulder machines • On request the cutters can be supplied with HS cutting edges

### Z=3+3+3

● = Készleten van ■ = Szállítási idő 20 munkanap ▲ = Rendelésre

D	S	F	Cikkszám
140	10÷55	30	▲ F265M14050AA
Spec. HW			F265M99
Spec. HS			F265S99

### PÓTALKATRÉSZEK

Megnevezés	Méret	Cikkszám
Felső maró	154X20	▲ F265M15420A1
Középső maró	140X50	▲ F265M14050A2
Alsó maró	154X20	▲ F265M15420A3

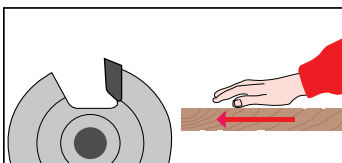
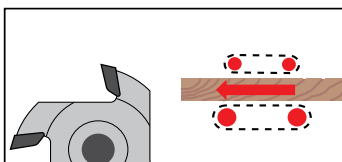
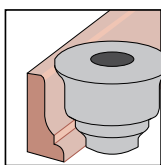
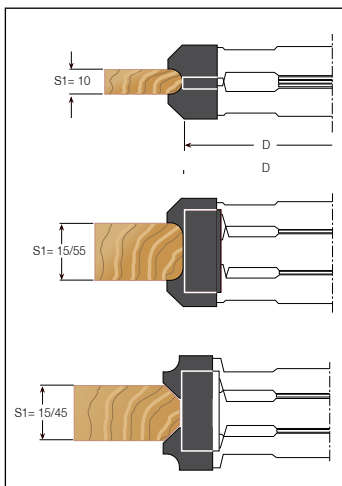
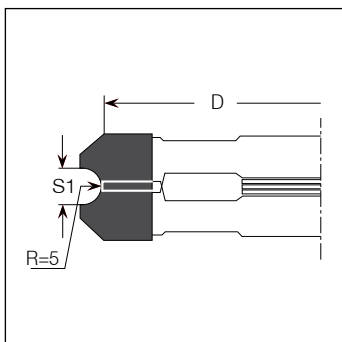

TAGLIO / SEZIONATURA  
SAWING

DIAMANTE  
DIAMOND

FRESATURA  
CUTTING

PANTOGRAFATURA  
ROUTING

FORATURA  
BORING

MANDRINI / ATTACCHI  
CHUCKS & CLAMPING SYSTEM

RICAMBI E LAVORAZIONI SUPP.  
SPARE PARTS & ADD. WORKING

## F290

## HW Többszörös tiplimarók

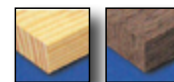

Edzett acélból készült test • 3 beforrasztott vidia vágóél • Két vagy több, különféle méretű sima tiplirúd kivitelezésére javasolt • Formázó marógépeken használható • Egyedi igény esetén a marók gyorsacél (HS) vágóélékkel is szállíthatók

Body in hardened and tempered steel • 3 HW brazed cutting edges • Indicated for the execution of two or more smooth dowels with several diameters • Can be used on moulder machines • On request the cutters can be supplied with HS cutting edges

## Z=3

● = Készleten van

■ = Szállítási idő 20 munkanap

△ = Rendelésre

D	S	d	b	c	Rudak	F	Cikkszám
120	19	5	1	4	2	40	△ F290M120052A
120	21	6	1	4	2	40	△ F290M120062A
120	25	8	1	4	2	40	△ F290M120082A
120	31	10	1	4	2	40	△ F290M120102A
120	35,5	12	1,5	5	2	40	△ F290M120122A
120	39,5	14	1,5	5	2	40	△ F290M120142A
140	43,5	16	1,5	5	2	40	△ F290M140162A
140	47,5	18	1,5	5	2	40	△ F290M140182A
140	52	20	1,5	5	2	40	△ F290M140202A
120	25	5	1	4	3	40	△ F290M120053A
120	28	6	1	4	3	40	△ F290M120063A
120	34	8	1	4	3	40	△ F290M120083A
120	42	10	1	4	3	40	△ F290M120103A
120	49	12	1,5	5	3	40	△ F290M120123A
120	55	14	1,5	5	3	40	△ F290M120143A
140	61	16	1,5	5	3	40	△ F290M140163A
140	67	18	1,5	5	3	40	△ F290M140183A
140	74	20	2	5	3	40	△ F290M140203A
120	31	5	1	4	4	40	△ F290M120054A
120	35	6	1	4	4	40	△ F290M120064A
120	43	8	1	4	4	40	△ F290M120084A
120	53	10	1	5	4	40	△ F290M120104A
120	62,5	12	1,5	5	4	40	△ F290M120124A
120	70,5	14	1,5	5	4	40	△ F290M120144A
140	78,5	16	1,5	5	4	40	△ F290M140164A
140	86,5	18	1,5	5	4	40	△ F290M140184A
140	96	20	2	5	4	40	△ F290M140204A
120	37	5	1	4	5	40	△ F290M120055A
120	42	6	1	4	5	40	△ F290M120065A
120	52	8	1	4	5	40	△ F290M120085A

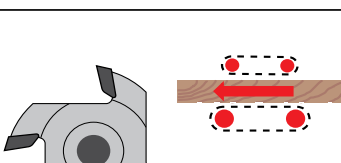
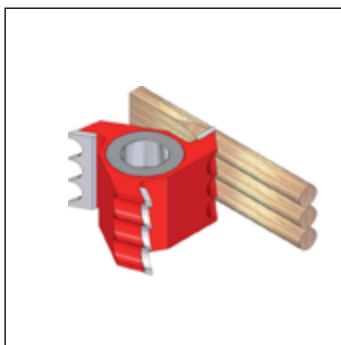
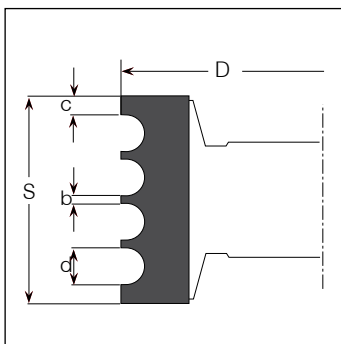
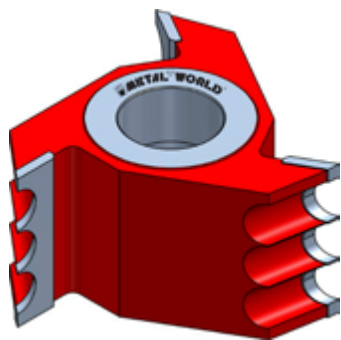

## F290

## HW Többszörös tiplimarók

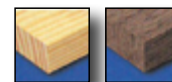
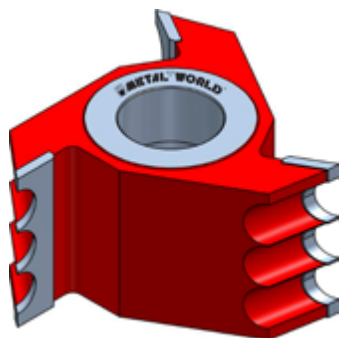

Edzett acélból készült test • 3 beforrasztott vágóél • Két vagy több, különféle méretű sima tiplirúd kivitelezésére javasolt • Formázó marógépeken használható • Egyedi igény esetén a marók gyorsacél (HS) vágóélekkel is szállíthatók

Body in hardened and tempered steel • 3 HW brazed cutting edges • Indicated for the execution of two or more smooth dowels with several diameters • Can be used on moulder machines • On request the cutters can be supplied with HS cutting edges

Z=3

● = Készleten van ■ = Szállítási idő 20 munkanap ▲ = Rendelésre

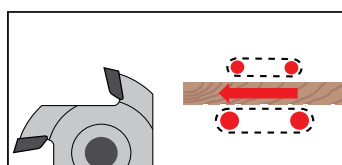
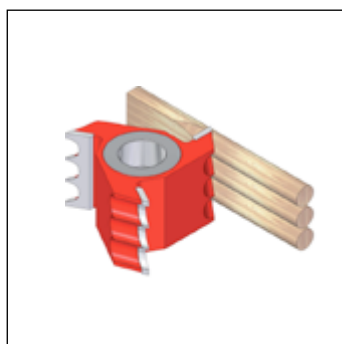
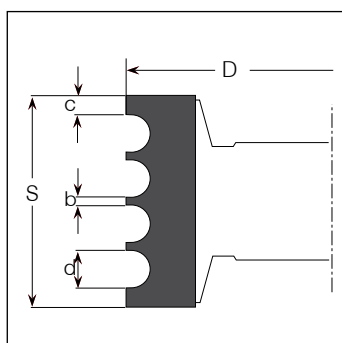

D	S	d	b	c	Rudak	F	Cikkszám
120	64	10	1	5	5	40	▲ F290M120105A
120	76	12	1,5	5	5	40	▲ F290M120125A
120	86	14	1,5	5	5	40	▲ F290M120145A
140	96	16	1,5	5	5	40	▲ F290M140165A
140	106	18	1,5	5	5	40	▲ F290M140185A
140	118	20	2	5	5	40	▲ F290M140205A
120	43	5	1	4	6	40	▲ F290M120056A
120	49	6	1	4	6	40	▲ F290M120066A
120	61	8	1	4	6	40	▲ F290M120086A
120	75	10	1	5	6	40	▲ F290M120106A
120	89,5	12	1,5	5	6	40	▲ F290M120126A
120	101,5	14	1,5	5	6	40	▲ F290M120146A
140	113,5	16	1,5	5	6	40	▲ F290M140166A
140	125,5	18	1,5	5	6	40	▲ F290M140186A
140	140	20	2	5	6	40	▲ F290M140206A
120	49	5	1	4	7	40	▲ F290M120057A
120	56	6	1	4	7	40	▲ F290M120067A
120	70	8	1	4	7	40	▲ F290M120087A
120	86	10	1	5	7	40	▲ F290M120107A
120	103	12	1,5	5	7	40	▲ F290M120127A
120	117	14	1,5	5	7	40	▲ F290M120147A
140	131	16	1,5	5	7	40	▲ F290M140167A
140	145	18	1,5	5	7	40	▲ F290M140187A
120	55	5	1	4	8	40	▲ F290M140058A
120	63	6	1	4	8	40	▲ F290M140068A
120	79	8	1	4	8	40	▲ F290M140088A
120	97	10	1	5	8	40	▲ F290M140108A
120	116,5	12	1,5	5	8	40	▲ F290M140128A
120	132,5	14	1,5	5	8	40	▲ F290M140148A
140	148,5	16	1,5	5	8	40	▲ F290M140168A

Spec. HW F290M99  
Spec. HS F290S99

TAGLIO / SEZIONATURA  
SAWINGDIAMANTE  
DIAMONDFRESATURA  
CUTTINGPANTOGRAFATURA  
ROUTINGFORATURA  
BORINGMANDRINI / ATTACCHI  
CHUCKS & CLAMPING SYSTEMRICAMBI E LAVORAZIONI SUPP.  
SPARE PARTS & ADD. WORKING

Bordásrúd marók

Vielstabfräser  
geriffeltFraise demi-ronde convexe  
pour bâtons

Фрезы для палочек

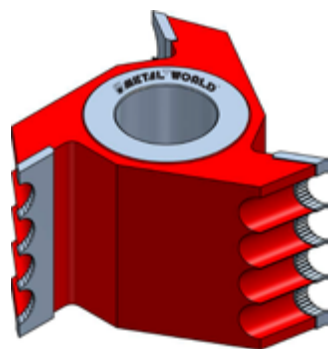
**F292****HW** Többszörös bordástipli marók

Edzett acélból készült test • 3 beforrasztott vidia vágóél • Két vagy több, különféle méretű bordás tiplirúd kivitelezésére javasolt • Formázó marógépeken használható • Egyedi igény esetén a marók gyorsacél (HS) vágóélekkel is szállíthatók

Body in hardened and tempered steel • 3 HW brazed cutting edges • Indicated for the execution of two or more knurled dowels with several diameters • Can be used on moulder machines • On request the cutters can be supplied with HS cutting edges

**Z=3**

● = Készleten van

■ = Szállítási idő 20 munkanap

△ = Rendelésre

D	S	d	b	c	Rudak	F	Cikkszám
120	19,4	5,2	1	4	2	40	△ F292M120052A
120	21,4	6,2	1	4	2	40	△ F292M120062A
120	25,4	8,2	1	4	2	40	△ F292M120082A
120	31,4	10,2	1	5	2	40	△ F292M120102A
120	35,9	12,2	1,5	5	2	40	△ F292M120122A
120	39,9	14,2	1,5	5	2	40	△ F292M120142A
120	25,6	5,2	1	4	3	40	△ F292M120053A
120	28,6	6,2	1	4	3	40	△ F292M120063A
120	34,6	8,2	1	4	3	40	△ F292M120083A
120	42,6	10,2	1	4	3	40	△ F292M120103A
120	49,6	12,2	1,5	5	3	40	△ F292M120123A
120	55,6	14,2	1,5	5	3	40	△ F292M120143A
120	31,8	5,2	1	4	4	40	△ F292M120054A
120	35,8	6,2	1	4	4	40	△ F292M120064A
120	43,8	8,2	1	4	4	40	△ F292M120084A
120	53,8	10,2	1	4	4	40	△ F292M120104A
120	63,3	12,2	1,5	5	4	40	△ F292M120124A
120	71,3	14,2	1,5	5	4	40	△ F292M120144A
120	38	5,2	1	4	5	40	△ F292M120055A
120	43	6,2	1	4	5	40	△ F292M120065A
120	53	8,2	1	4	5	40	△ F292M120085A
Spec. HW							F292M99
Spec. HS							F292S99

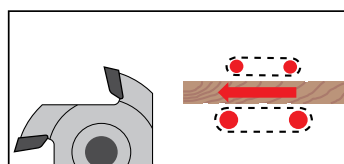
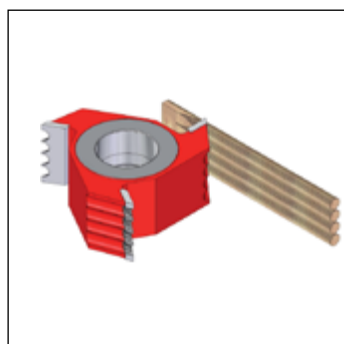
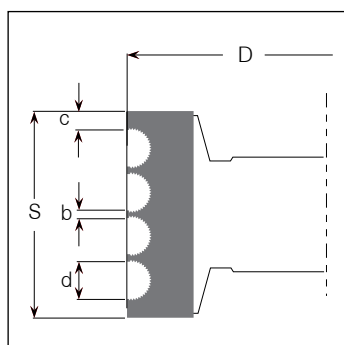
TAGLIO / SEZIONATURA  
SAWINGDIAMANTE  
DIAMONDFRESATURA  
CUTTINGPANTOGRAFATURA  
ROUTINGFORATURA  
BORINGMANDRINI / ATTACCHI  
CHUCKS & CLAMPING SYSTEMRICAMBI E LAVORAZIONI SUPP.  
SPARE PARTS & ADD. WORKING

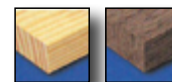
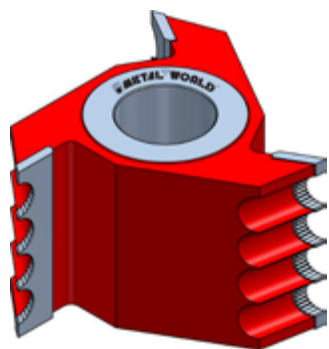
**F292****HW** Többszörös bordástipli marók

Edzett acélból készült test • 3 beforrasztott vágóél • Két vagy több, különféle méretű bordás tiplirúd kivitelezésére javasolt • Formázó marógépeken használható • Egyedi igény esetén a marók gyorsacél (HS) vágóélekkel is szállíthatók

Body in hardened and tempered steel • 3 HW brazed cutting edges • Indicated for the execution of two or more knurled dowels with several diameters • Can be used on moulder machines • On request the cutters can be supplied with HS cutting edges

**Z=3**

● = Készleten van ■ = Szállítási idő 20 munkanap ▲ = Rendelésre

D	S	d	b	c	Rudak	F	Cikkszám
120	65	10,2	1	5	5	40	▲ F292M120105A
120	77	12,2	1,5	5	5	40	▲ F292M120125A
120	87	14,2	1,5	5	5	40	▲ F292M120145A
120	44,2	5,2	1	4	6	40	▲ F292M120056A
120	50,2	6,2	1	4	6	40	▲ F292M120066A
120	62,2	8,2	1	4	6	40	▲ F292M120086A
120	76,2	10,2	1	5	6	40	▲ F292M120106A
120	90,7	12,2	1,5	5	6	40	▲ F292M120126A
120	102,7	14,2	1,5	5	6	40	▲ F292M120146A
120	50,4	5,2	1	4	7	40	▲ F292M120057A
120	57,4	6,2	1	4	7	40	▲ F292M120067A
120	71,4	8,2	1	4	7	40	▲ F292M120087A
120	87,4	10,2	1	5	7	40	▲ F292M120107A
120	104,4	12,2	1,5	5	7	40	▲ F292M120127A
120	118,4	14,2	1,5	5	7	40	▲ F292M120147A
120	56,6	5,2	1	4	8	40	▲ F292M120058A
120	64,6	6,2	1	4	8	40	▲ F292M120068A
120	80,6	8,2	1	4	8	40	▲ F292M120088A
120	102,1	10,2	1,5	5	8	40	▲ F292M120108A
120	118,1	12,2	1,5	5	8	40	▲ F292M120128A
120	134,1	14,2	1,5	5	8	40	▲ F292M120148A
Spec. HW							F292M99
Spec. HS							F292S99

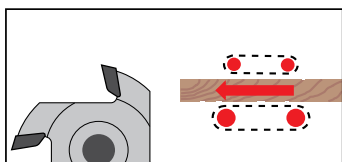
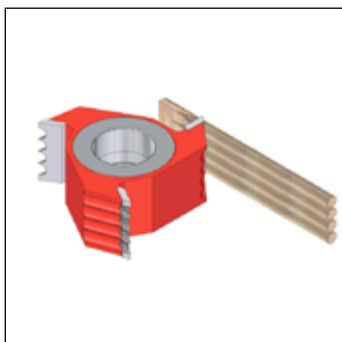
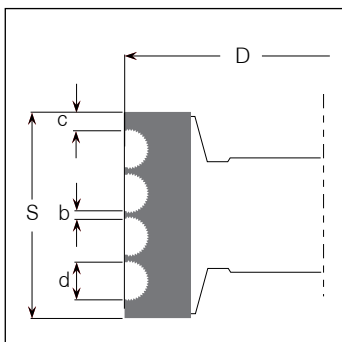
TAGLIO / SEZIONATURA  
SAWINGDIAMANTE  
DIAMONDFRESATURA  
CUTTINGPANTOGRAFATURA  
ROUTINGFORATURA  
BORINGMANDRINI / ATTACCHI  
CHUCKS & CLAMPING SYSTEMRICAMBI E LAVORAZIONI SUPP.  
SPARE PARTS & ADD. WORKING

## F300

## HW Ragasztási toldómarók

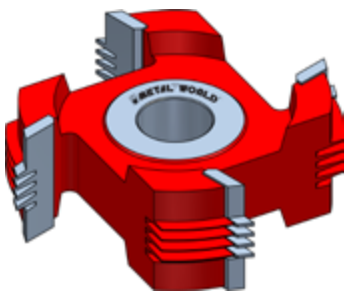
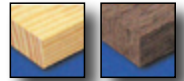

Edzett acélból készült test • 4 beforrasztott vidia vágóél • Fix profilú ragasztási illesztések kivitelezésére javasolt • Az A / B / C profilok hosszirányú toldásra alkalmasak • A D / E / F / G / H / I profilok keresztirányú toldásra alkalmasak • Asztali marókra, formázó marókra, stb. szerelhető • Egyedi igény esetén a marók gyorsacél (HS) vágóélekkel is szállíthatók

Body in hardened and tempered steel • 4 HW brazed cutting edges • Indicated for the execution of joints with fixed profiled part • Profiles A / B / C suitable for joints along the grain • Profiles D / E / F / G / H / I indicated for joints against the grain • Can be used on toupie, moulder machines and double end tenoners machines • On request the cutters can be supplied with HS cutting edges

Z=4

● = Készleten van

■ = Szállítási idő 20 munkanap

△ = Rendelésre

D	S	Profil	F	Cikkszám
140	40	A	40	△ F300M14040AA
140	50	B	40	△ F300M14050BA
140	60	C	40	△ F300M14060CA
140	40	D	40	△ F300M14040DA
140	50	E	40	△ F300M14050EA
140	60	F	40	△ F300M14060FA
140	40	G	40	△ F300M14040GA
140	50	H	40	△ F300M14050HA
140	60	I	40	△ F300M14060IA
Spec. HW				F300M99
Spec. HS				F300S99

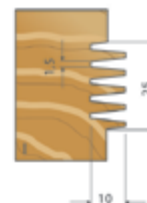
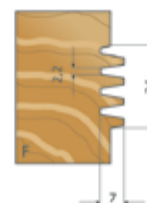
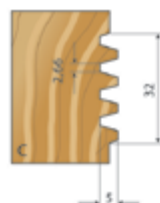
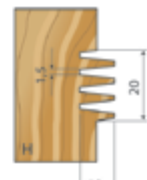
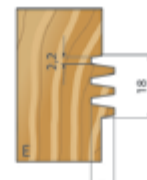
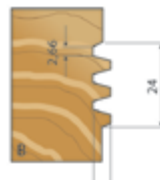
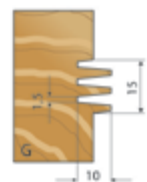
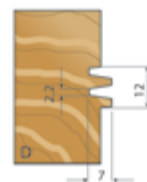
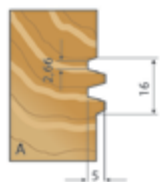
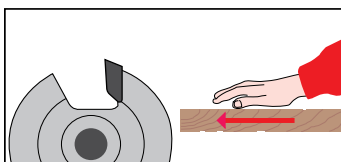
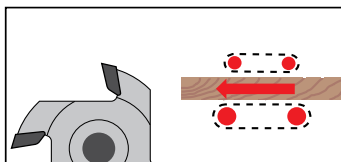
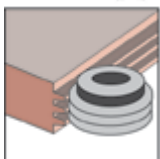
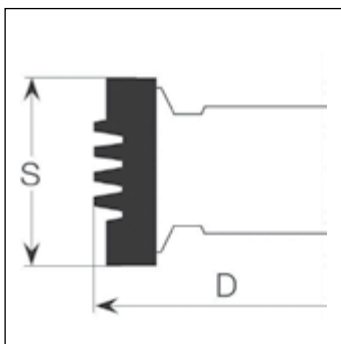



# F301 HW Állítható toldómarók

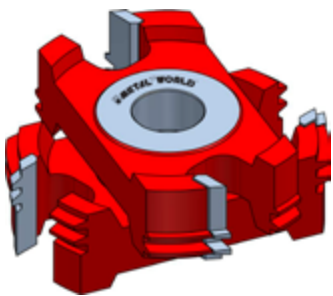
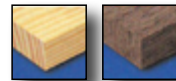

Edzett acélból készült test • 2+2 beforrasztott vedia vágóél • Állítható magasságú illesztések kivitelezésére javasolt • Asztali marókra, formázó marókra, stb. szerelhető • Egyedi igény esetén a marók gyorsacél (HS) vágóélekkel is szállíthatók

Body in hardened and tempered steel • 2+2 HW brazed cutting edges • Indicated for the execution of joints with adjustable height • Can be used on toupie and moulder machines • On request the cutters can be supplied with HS cutting edges

**Z=2+2**

● = Készleten van   ■ = Szállítási idő 20 munkanap   ▲ = Rendelésre

D	S min.	S max	Profil	F	Cikkszám
140	20	60	A	40	▲ F301M14020AA
140	16	60	B	40	▲ F301M14016BA

Spec. HW					F301M99
Spec. HS					F301S99

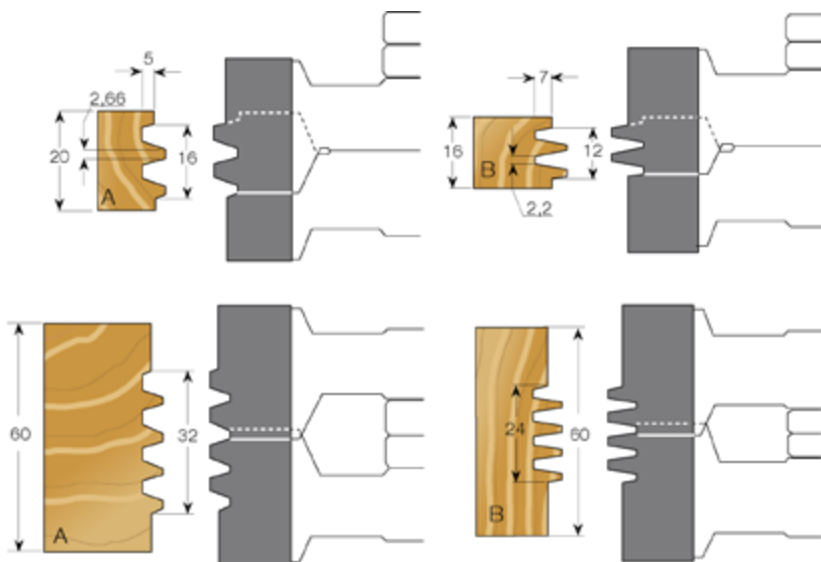
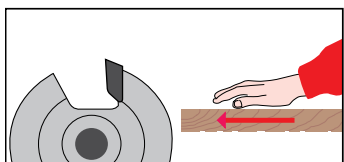
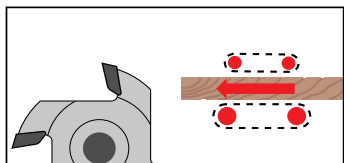
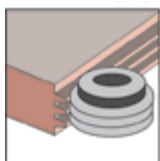
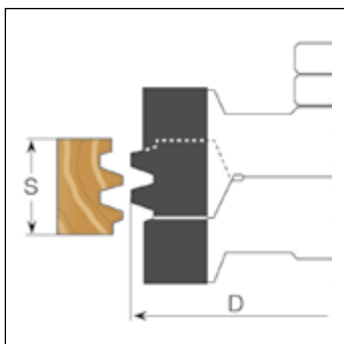

TAGLIO / SEZIONATURA  
SAWING

DIAMANTE  
DIAMOND

FRESATURA  
CUTTING

PANTOGRAFATURA  
ROUTING

FORATURA  
BORING

MANDRINI / ATTACCHI  
CHUCKS & CLAMPING SYSTEM

RICAMBI E LAVORAZIONI SUPP.  
SPARE PARTS & ADD. WORKING

Toldómarók

Verleim-Fräser

Fraises pour joints collés

Фрезы для сращивания

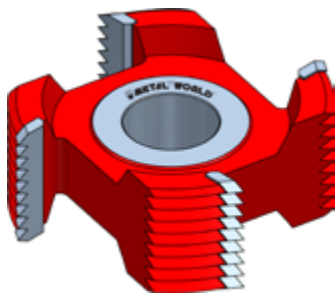
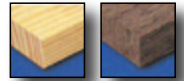
**F304****HW Ragasztási toldómarók**

Edzett acélból készült test • 4 beforrasztott vidia vágóél • Bútorajtók toldásainak kivitelezésére ajánlott • Asztali marókra, formázó marókra szerelhető

Body in hardened and tempered steel • 4 HW brazed cutting edges • Indicated for the execution of joints for furniture doors • Can be used on toupie and moulder machines

**Z=4**

● = Készleten van

■ = Szállítási idő 20 munkanap

△ = Rendelésre

D	S	F	Cikkszám
140	50	40	△ F304M14050AA
140	85	40	△ F304M14085AA
Spec.			F304M99

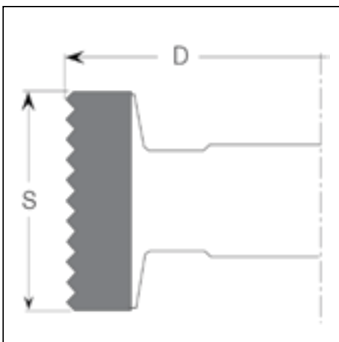
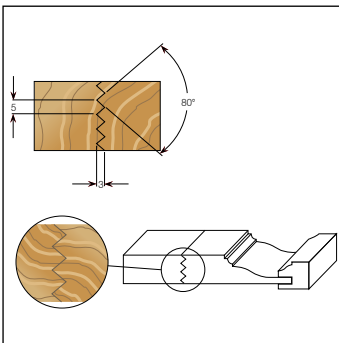
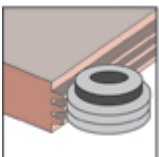
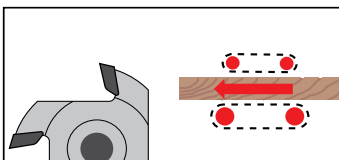
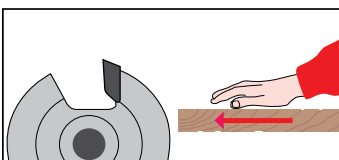
TAGLIO / SEZIONATURA  
SAWINGDIAMANTE  
DIAMONDFRESATURA  
CUTTINGPANTOGRAFATURA  
ROUTINGFORATURA  
BORINGMANDRINI / ATTACCHI  
CHUCKS & CLAMPING SYSTEMRICAMBI E LAVORAZIONI SUPP.  
SPARE PARTS & ADD. WORKING



# F305

## HW Állítható toldómarók

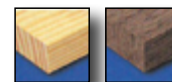
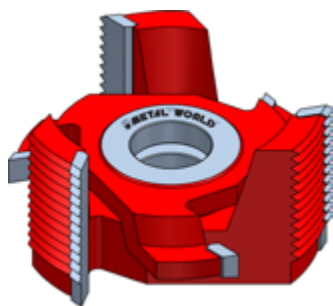

Edzett acélból készült test • 3 beforrasztott vidia vágóél minden marónál • Bútorajtók toldásainak kivitelezésére ajánlott • Asztali marókon, formázó marókon használható

Body in hardened and tempered steel • 3 HW brazed cutting edges for each tool • Indicated for the execution of joints of furniture doors • Can be used on toupie and moulder machines

**Z=3+3**

● = Készleten van   ■ = Szállítási idő 20 munkanap   △ = Rendelésre

D	S	Profil	F	Cikkszám
140	80	A	40	△ F305M14080AA
140	80	B	40	△ F305M14080BA
Spec.				F305M99

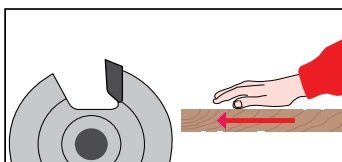
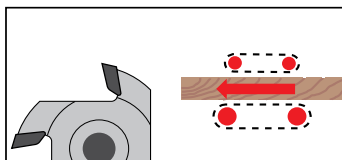
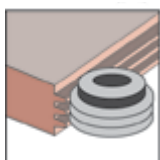
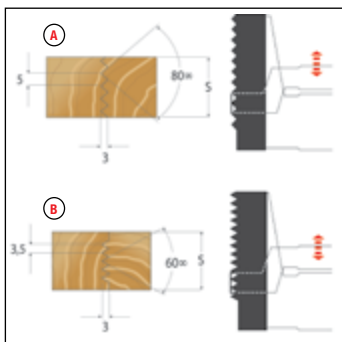
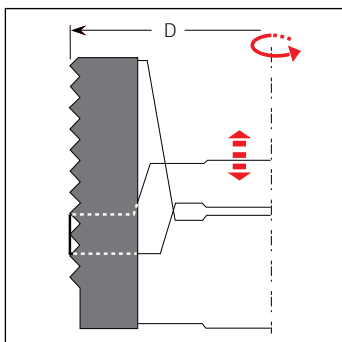

TAGLIO / SEZIONATURA  
SAWING

DIAMANTE  
DIAMOND

FRESATURA  
CUTTING

PANTOGRAFATURA  
ROUTING

FORATURA  
BORING

MANDRINI / ATTACCHI  
CHUCKS & CLAMPING SYSTEM

RICAMBI E LAVORAZIONI SUPP.  
SPARE PARTS & ADD. WORKING

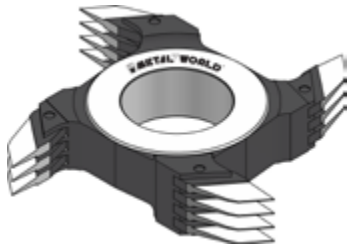
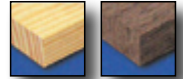
**F306****HS Minizinken toldómarók**

Edzett acélból készült test • Gyorsacél (HS) vágóélek • Puhafa gerendák, pallók toldásának kivitelezésére ajánlott • Asztali marókon, formázó marókon használható

Body in hardened and tempered steel • HS cutting edges • Indicated for the execution of joints or beams of softwood • Can be used on toupie and moulder machines

● = Készleten van ■ = Szállítási idő 20 munkanap ▲ = Rendelésre

D	S	F	Z	Profil	L	Cikkszám
160	26	50	2+2	A	4	▲ F306S16026AA
160	28,6	50	2+2	B	10/10	▲ F306S16028BB
160	28,6	50	2+2	B	10/11	▲ F306S16028BB
250	28,6	50	3+3	B	10/10	▲ F306S25028BA
250	28,6	50	3+3	B	10/11	▲ F306S25028BB
Spec.						F306S99

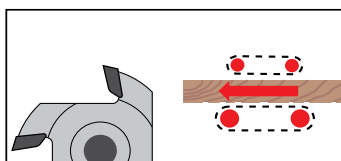
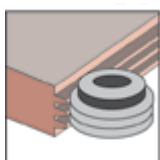
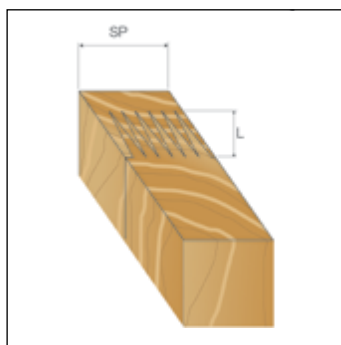
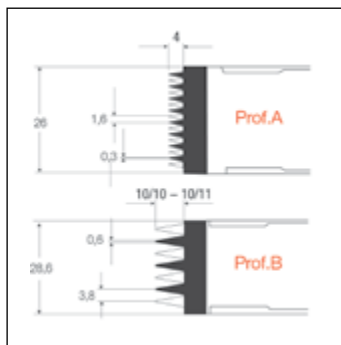
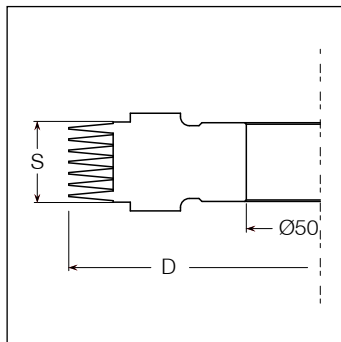

Profil	L	SP	marók száma
A	4	25	1
A	4	49	2
A	4	73	3
A	4	97	4
A	4	121	5
A	4	145	6
A	4	169	7
A	4	193	8
A	4	217	9
A	4	241	10
B	10	24	1
B	10	51	2
B	10	77	3
B	10	104	4
B	10	131	5
B	10	157	6
B	10	184	7
B	10	210	8
B	10	237	9
B	10	264	10

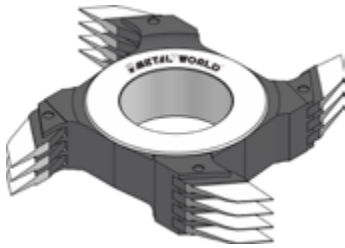
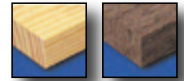
**F306****HS Minizinken toldómarók**

Edzett acélból készült test • Gyorsacél (HS) vágóélek • Puhafa gerendák, pallók toldásának kivitelezésére ajánlott • Asztali marókon, formázó marókon használható

Body in hardened and tempered steel • HS cutting edges • Indicated for the execution of joints or beams of softwood • Can be used on toupie and moulder machines

● = Készleten van ■ = Szállítási idő 20 munkanap ▲ = Rendelésre

D	S	F	Z	Profil	L	Cikkszám
170	28,6	50	2+2	C	15/15	▲ F306S17028CA
170	28,6	50	2+2	C	15/16,5	▲ F306S17028CB
260	28,6	50	3+3	C	15/15	▲ F306S26028CA
260	28,6	50	3+3	C	15/16,5	▲ F306S26028CB
180	33	50	2+2	D	20/20	▲ F306S18033DA
180	33	50	2+2	D	20/22	▲ F306S18033DB
260	33	50	3+3	D	20/22	▲ F306S26033DA

Spec.

F306S99

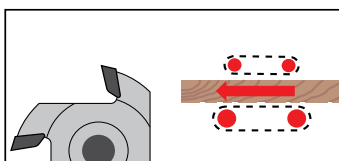
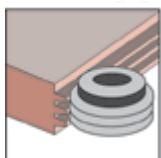
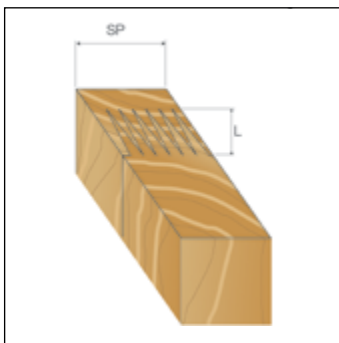
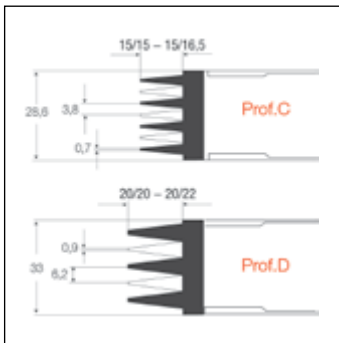
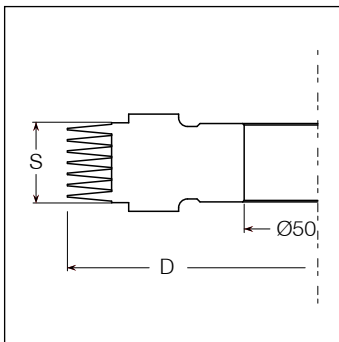

Profil	L	SP	marók száma
C	15	24	1
C	15	51	2
C	15	77	3
C	15	104	4
C	15	131	5
C	15	157	6
C	15	184	7
C	15	210	8
C	15	237	9
C	15	264	10
D	20	28	1
D	20	59	2
D	20	90	3
D	20	121	4
D	20	152	5
D	20	183	6
D	20	214	7
D	20	245	8
D	20	276	9
D	20	307	10

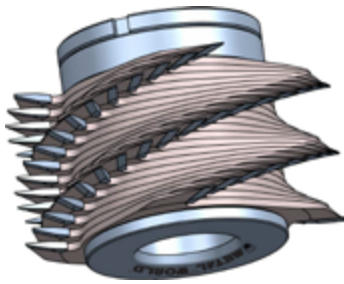
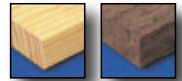
**F307****HW** Minizinken toldómarók és vállas marók

Tömör puha- és keményfa bútű toldására • Gyorsacél (HS) vágóélek • 3,8 mm osztású, 10/11 profilú • Véglevágó fűrészszel felszerelt toldómaró gépekre alkalmas • Spirálfogas konfigurációra alkalmas

For end grain jointing of solid wood, soft or hard wood • HW cutting edges - Pitch 3,8 mm and profile 10/11 • Suitable for Finger joint machines equipped with cut-off saw • Suitable for spiral tooth configuration

**Z=4/6**

● = Készleten van

■ = Szállítási idő 20 munkanap

△ = Rendelésre

D	S	F	Z	L	Cikkszám
160	3,8	70	4	10/11	△ F307M16038AA
250	3,8	70	6	10/11	△ F307M25038AA
160	11,4	70	4	10/11	△ F307M160114A
250	11,4	70	6	10/11	△ F307M250114A

Spec.					F307M99
-------	--	--	--	--	---------

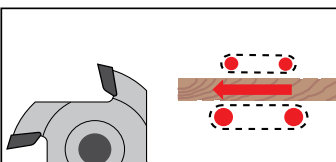
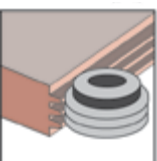
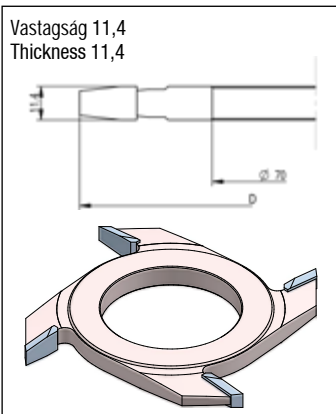
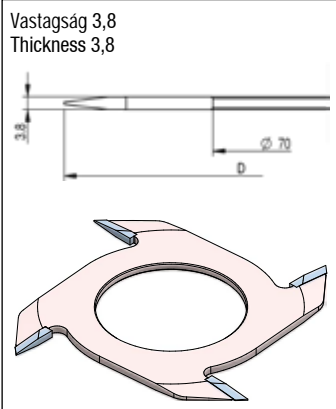



# F310

## HW Megfordítható gér toldómarók



Edzett acélból készült test • 3+3 beforrasztott vágóél • Ks méretű tokok, keretek, fiókok kivitelezésére ajánlott • Kétféle kivitelben kapható • Asztali marókon, formázó marókon használható

Body in hardened and tempered steel • 3+3 HW brazed cutting edges • Indicated for the execution of frames • Can be used on toupie and moulder machines • Available in two models

### Z=3+3

● = Készleten van   ■ = Szállítási idő 20 munkanap   △ = Rendelésre

D	S	F	Z	Mod.	Cikkszám
160	35	40	3+3	A	△ F310M16035AA
180	35	40	3+3	A	△ F310M18035AA
160	35	40	3+3	B	△ F310M16035BA
180	35	40	3+3	B	△ F310M18035BA
Spec.					F310M99

\* Megrendeléskor meg kell adni a maró modell típusát: A vagy B

\* When ordering, specify the type of cutter: A or B

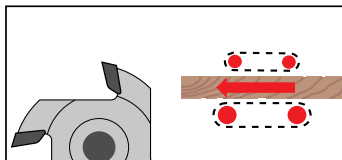
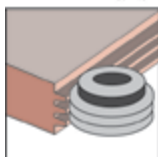
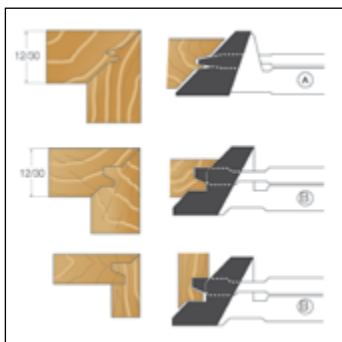
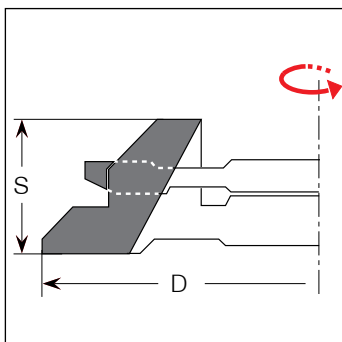

TAGLIO / SEZIONATURA  
SAWING

DIAMANTE  
DIAMOND

FRESATURA  
CUTTING

PANTOGRAFATURA  
ROUTING

FORATURA  
BORING

MANDRINI / ATTACCHI  
CHUCKS & CLAMPING SYSTEM

RICAMBI E LAVORAZIONI SUPP.  
SPARE PARTS & ADD. WORKING

Távtartókkal állítható parkettamarók

Nut und Federfräser verstellbar

Jeu de fraises réglables à tenon pour parquet HW

Фрезы для паркетных линий регулируемые

**F330**

**HW** Állítható csap- és horonymarók

TAGLIO / SEZIONATURA  
SAWING

DIAMANTE  
DIAMOND

FRESATURA  
CUTTING

PANTOGRAFATURA  
ROUTING

FORATURA  
BORING

MANDRINI / ATTACCHI  
CHUCKS & CLAMPING SYSTEM

RICAMBI E LAVORAZIONI SUPP.  
SPARE PARTS & ADD. WORKING

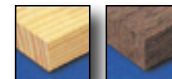
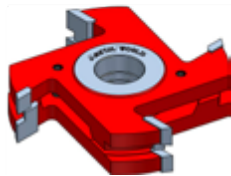
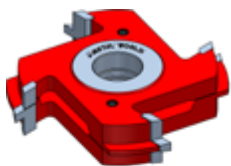

Edzett acélból készült test • 4 beforrasztott vidia vágóél • Különféle vastagságú tömörfa parketták kivitelezésére javasolt  
• Asztali marókon, formázó marókon használható • Egyedi igény esetén a marók gyorsacél (HS) vágóélekkel is szállíthatók

Body in hardened and tempered steel • 4 HW brazed cutting edges • Indicated for the execution of flooring of different thickness, on solid wood • Can be used on toupie and moulder machines • On request the cutters can be supplied with HS cutting edges

**Z=4**

● = Készleten van ■ = Szállítási idő 20 munkanap ▲ = Rendelésre

D	S	S Max	Típus	F	Cikkszám
160	4÷7,5	20	A	40	▲ F330M16004AA
160	4÷7,5	20	B	40	▲ F330M16004BA

Spec. HW					F330M99
Spec. HS					F330S99

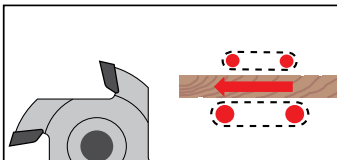
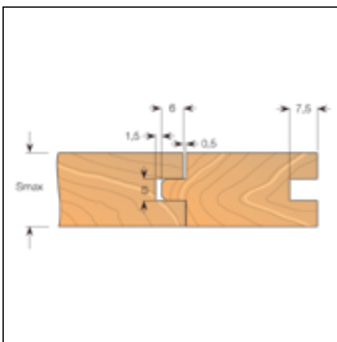
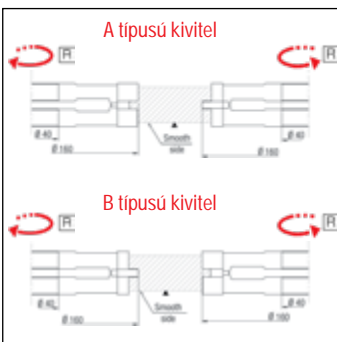



# F340 HW Állítható csap- és horonymarók

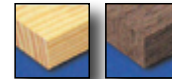
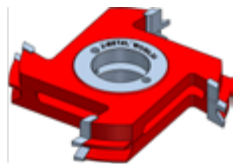

Edzett acélból készült test • 4 beforrasztott vídia vágóél • Különbféle vastagságú tömörfa lambériák kivitelezésére javasolt a távtartógyűrűk használatának köszönhetően • Asztali marókon, formázó marókon használható • Egyedi igény esetén a marók gyorsacél (HS) vágóélékkel is szállíthatók



Body in hardened and tempered steel • 4 HW brazed cutting edges • Indicated for the execution of tongue and grooves of different thickness on solid wood due to spacers • Can be used on toupie and moulder machines • On request the cutters can be supplied with HS cutting edges

Z=4

● = Készleten van   ■ = Szállítási idő 20 munkanap   ▲ = Rendelésre

D	S	S Max	Típus	Profil	F	Cikkszám
160	4÷7,5	20	A	1	40	▲ F340M160201A
160	4÷7,5	20	B	1	40	▲ F340M160201B
160	4÷7,5	20	A	2	40	▲ F340M160202A
160	4÷7,5	20	B	2	40	▲ F340M160202B
160	6÷11	30	A	1	40	▲ F340M160301A
160	6÷11	30	B	1	40	▲ F340M160301B
160	6÷11	30	A	2	40	▲ F340M160302A
160	6÷11	30	B	2	40	▲ F340M160302B

Spec. HW						F340M99
Spec. HS						F340S99

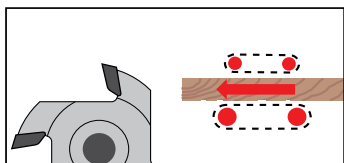
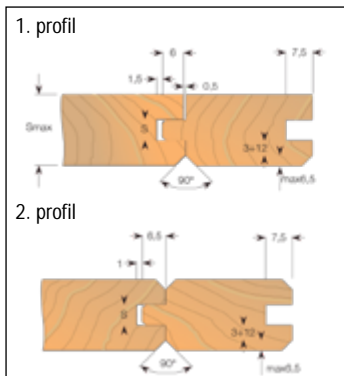
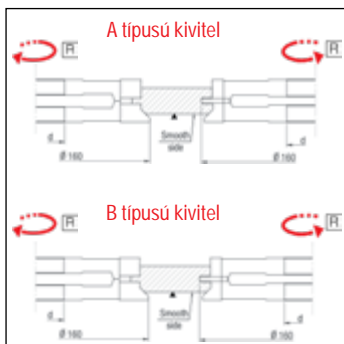

TAGLIO / SEZIONATURA SAWING

DIAMANTE DIAMOND

FRESATURA CUTTING

PANTOGRAFATURA ROUTING

FORATURA BORING

MANDRINI / ATTACCHI CHUCKS & CLAMPING SYSTEM

RICAMBI E LAVORAZIONI SUPP. SPARE PARTS & ADD. WORKING



Távtartókkal állítható  
lambériamarók  
elővágóval



Nut und Federfräser  
verstellbar



Jeu de fraises réglables à  
mortaise pour lambris HW



Фрезы для вагонки  
регулируемые

TAGLIO / SEZIONATURA  
SAWING

DIAMANTE  
DIAMOND

FRESATURA  
CUTTING

PANTOGRAFATURA  
ROUTING

FORATURA  
BORING

MANDRINI / ATTACCHI  
CHUCKS & CLAMPING SYSTEM

RICAMBI E LAVORAZIONI SUPP.  
SPARE PARTS & ADD. WORKING

**F350**

**HW** Állítható csap- és horonymarók

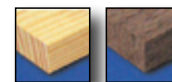
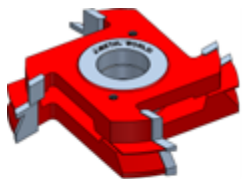

Edzett acélból készült test • 4 vágó + 4 elővágó beforrasztott vidia él • Különféle vastagságú tömörfa lambériák kivitelezésére javasolt a távtartógyűrűk használata révén • Jó felületminőség az elővágóknak köszönhetően • Asztali marógépeken és formázó marógépeken használható • Egyedi igény esetén a marók gyorsacél (HS) vágóélekkel is szállíthatók

Body in hardened and tempered steel • 4 cutting edges + 4 spurs brazed in HW • Indicated for the execution of tongue and grooves of different thickness on solid wood due to spacers • Good finish thanks to the presence of spurs • Can be used on toupie and moulder machines • On request the cutters can be supplied with HS cutting edges

**Z=4 V=4**

● = Készleten van

■ = Szállítási idő 20 munkanap

△ = Rendelésre

D	S	S Max	Típus	Profil	F	Cikkszám
160	4÷7,5	20	A	1	40	△ F350M160201A
160	4÷7,5	20	B	1	40	△ F350M160201B
160	4÷7,5	20	A	2	40	△ F350M160202A
160	4÷7,5	20	B	2	40	△ F350M160202B
160	6÷11	30	A	1	40	△ F350M160301A
160	6÷11	30	B	1	40	△ F350M160301B
160	6÷11	30	A	2	40	△ F350M160302A
160	6÷11	30	B	2	40	△ F350M160302B

Spec. HW  
Spec. HS

F350M99  
F350S99

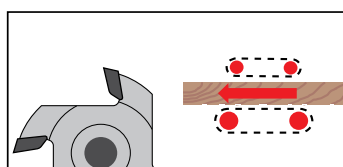
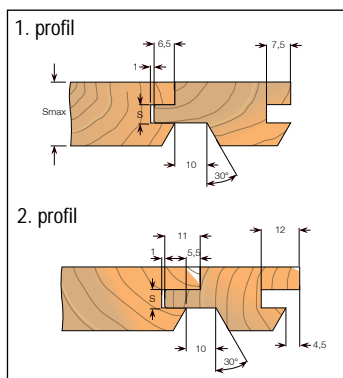
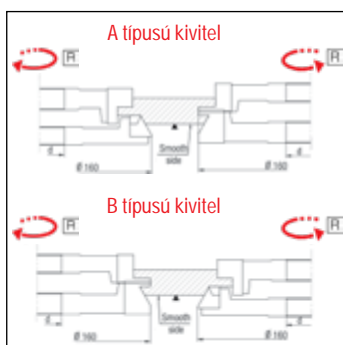





**F370** **HW** Marókészlet dupla végprofilozó géphez

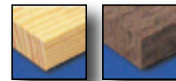
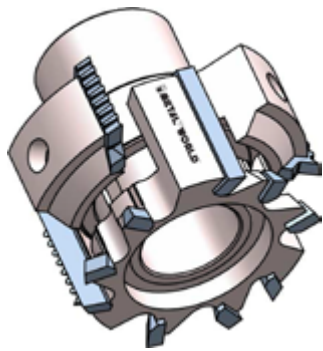

Edzett acélból készült test • 3+3 vágó + 6 elővágó beforrasztott vidia él • Forgácstörő a megmunkálás megkönnyítésére • Bacci és Balestrini dupla végprofilozó gépeken használható

Body in hardened and tempered steel • 3+3 cutting edges + 6 spurs brazed in HW • Chipbreaker to reduce the effort of processing • Can be used on Bacci e Balestrini tenoning machines

**Z=3+3 V=6**

● = Készleten van ■ = Szállítási idő 20 munkanap ▲ = Rendelésre

D	S	S1	F	Balos cikkszám	Jobbos cikkszám
60	65	9,5/30	25	▲ F370M06065AL	▲ F370M06065AR
Spec.				F370M99L	F370M99R

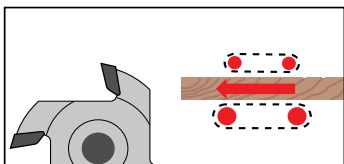
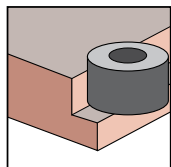
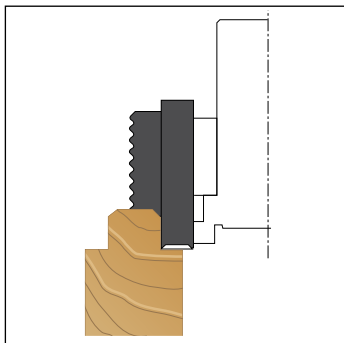
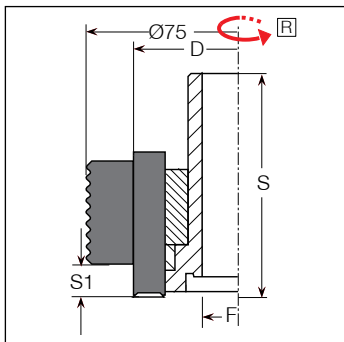

TAGLIO / SEZIONATURA  
SAWING

DIAMANTE  
DIAMOND

FRESATURA  
CUTTING

PANTOGRAFATURA  
ROUTING

FORATURA  
BORING

MANDRINI / ATTACCHI  
CHUCKS & CLAMPING SYSTEM

RICAMBI E LAVORAZIONI SUPP.  
SPARE PARTS & ADD. WORKING

Állítható csapmarók

Zapfenfräser

Jeu de fraises pour tenonneuse double

Комплект фрез для двусторонних шипорезных станков

**F372**

**HW** Marókészlet dupla végprofilozó géphez

TAGLIO / SEZIONATURA  
SAWING

DIAMANTE  
DIAMOND

FRESATURA  
CUTTING

PANTOGRAFATURA  
ROUTING

FORATURA  
BORING

MANDRINI / ATTACCHI  
CHUCKS & CLAMPING SYSTEM

RICAMBI E LAVORAZIONI SUPP.  
SPARE PARTS & ADD. WORKING

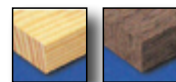

Edzett acélból készült test • Beforrasztott vidia vágóélek • A többfogú forgácstörő maró 12 részre osztása megnöveli a forgácskibocsátási kapacitást • Bacci és Balestrini dupla végprofilozó gépeken használható

Body in hardened and tempered steel • 3+3 cutting edges + 6 spurs brazed in HW • The multi-teeth hogging cutter have 12 multi-teeth divisions to increase the chip removal • Can be used on Bacci e Balestrini tenoning machines

**Z=3 V=6**

● = Készleten van   ■ = Szállítási idő 20 munkanap   △ = Rendelésre

D	S	S1	F	Balos cikkszám	Jobbos cikkszám
60	65	12/28	25	△ F372M06065AL	△ F372M06065AR
Spec.				F372M99L	F372M99R

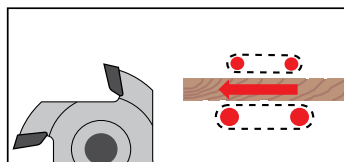
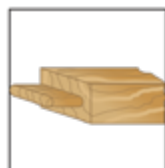
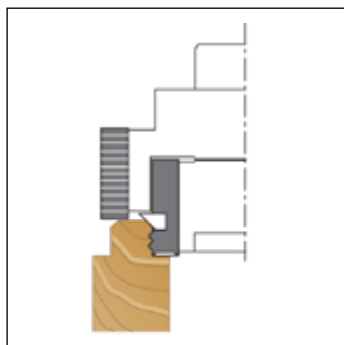
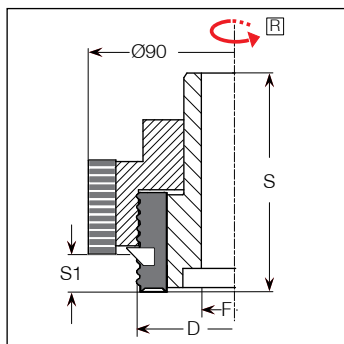

Állítható csapmarók

Zapfenfräser

Jeu de fraises pour tenonneuse double

Комплект фрез для двусторонних шипорезных станков

**F374**

**HW** Marókészlet dupla végprofilozó géphez

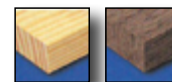
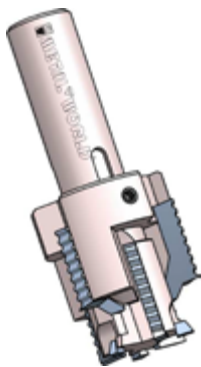

Edzett acélból készült test • 3+3 vágó + 3 elővágó beforrasztott vidia él • Forgácstörő a megmunkálás megkönnyítésére • CNC gépeken használható

Body in hardened and tempered steel • 3+3 cutting edges + 3 spurs brazed in HW • Chipbreaker to reduce the effort of processing • Can be used on CNC machines

**Z=3+3 V=3**

● = Készleten van ■ = Szállítási idő 20 munkanap ▲ = Rendelésre

D	D1	S	d	Balos cikkszám	Jobbos cikkszám
45	30	10÷30	20	▲ F374M04510AL	▲ F374M04510AR
Spec.				F374M99L	F374M99R

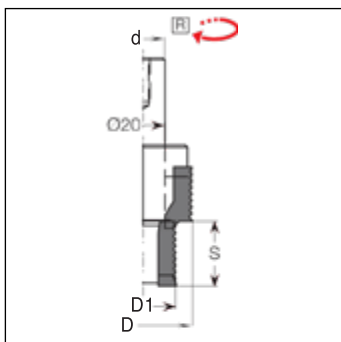

Állítható csapmarók

Zapfenfräser

Jeu de fraises pour tenonneuse double

Комплект фрез для двусторонних шипорезных станков

**F375**

**HW / HWM** Marókészlet dupla végprofilozó géphez

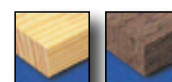
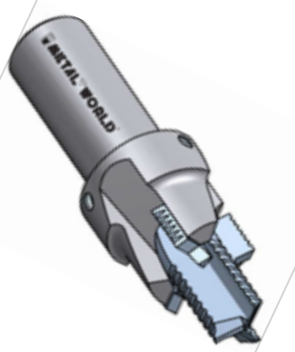

Edzett acélból készült test • 3+3 vágó + 3 elővágó beforrasztott vidia él • Tömör vidia központi fúróél • Forgácstörővel kiegészítve megkönnyíti a megmunkálást • CNC gépeken használható

Body in hardened and tempered steel • 3 cutting edges + 3 spurs brazed in HW • Central router bit in full HW • Complete with chipbreaker to reduce the effort of processing • Can be used on CNC machines

**Z=3+3 V=3**

● = Ready in stock ■ = Delivery time 20 working days ▲ = On request

D	D1	S	d	Left Code	Right Code	€
33	18	15÷25	25	▲ F375M03315AL	▲ F375M03315AR	
Spec.				F375M99L	F375M99R	

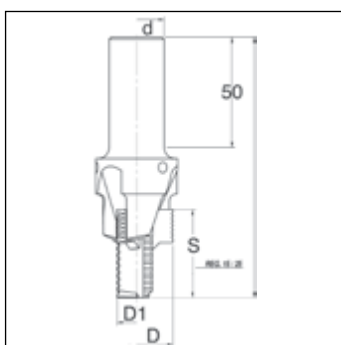

Gyűrűsanyával állítható csapmarók

Zapfenfräser mit Gewindebüchse

Jeu de fraises pour tenonneuse avec douille de réglage

Комплект фрез с градуированной гайкой для двусторонних шипорезных станков

**F378**

**HW** Csapmaró készletek gyűrűsanyával

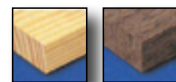

Edzett acélból készült test • 3+3 beforrasztott vídia vágóél 6 forgácstörös elővágóval • A gyűrűsanya könnyű, gyors és pontos beállítást tesz lehetővé • Bacci és Balestrini dupla végprofilozó gépeken használható

Body in hardened and tempered steel • 3+3 cutting edges with chipbreaker + 6 spurs brazed in HW • Ring nut grants an easy, fast and accurate setting • Can be used on Bacci e Balestrini double end tenoning machines

**Z=3+3 V=6**

● = Készleten van ■ = Szállítási idő 20 munkanap ▲ = Rendelésre

D	S	S1	F	Balos cikkszám	Jobbos cikkszám
70	67	9,5÷27,5	25	▲ F378M07067AL	▲ F378M07067AR
70	72	9,5÷30	25	▲ F378M07072AL	▲ F378M07072AR
Spec.				F378M99L	F378M99R

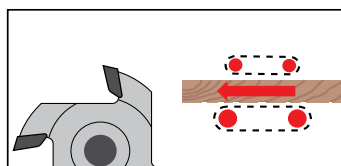
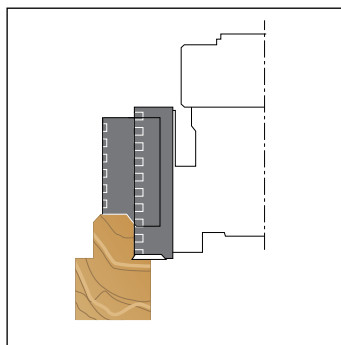
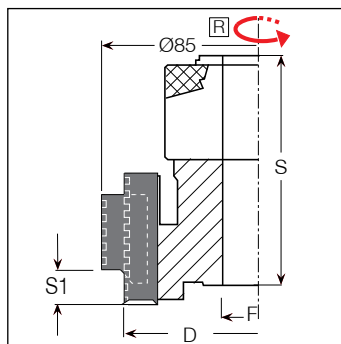
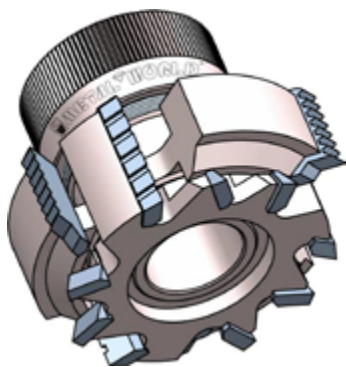

TAGLIO / SEZIONATURA  
SAWING

DIAMANTE  
DIAMOND

FRESATURA  
CUTTING

PANTOGRAFATURA  
ROUTING

FORATURA  
BORING

MANDRINI / ATTACCHI  
CHUCKS & CLAMPING SYSTEM

RICAMBI E LAVORAZIONI SUPP.  
SPARE PARTS & ADD. WORKING



# F382

## HW Csapmaró készletek gyűrűsanyával

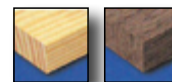
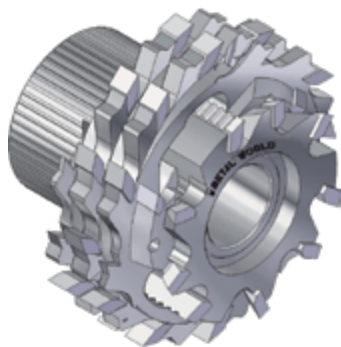

Edzett acélból készült test • 3 beforrasztott vedia vágóél • A többfogú forgáctörő maró 12 részre osztása megnöveli a forgácskibácsi kapacitást • A gyűrűsanya könnyű, gyors és pontos beállítást tesz lehetővé • Bacci és Balestrini dupla végprofilozó gépeken használható

Body in hardened and tempered steel • 3 HW brazed cutting edges • The multi-teeth hogging cutter have 12 multi-teeth divisions to increase the chip removal • Ring nut grants an easy, fast and accurate setting • Can be used on double end tenoning machines

**Z=3 V=6**

● = Készleten van ■ = Szállítási idő 20 munkanap ▲ = Rendelésre

D	S	S1	F	Balos cikkszám	Jobbos cikkszám
70	65	12/28	25	▲ F382M07065AL	▲ F382M07065AR
70	75	12/33,5	25	▲ F382M07075AL	▲ F382M07075AR
70	90	12/40	25	▲ F382M07090AL	▲ F382M07090AR
Spec.				F382M99L	F382M99R

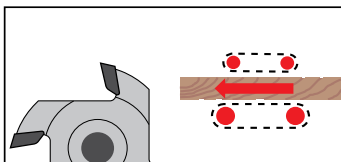
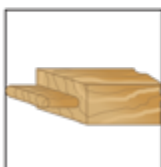
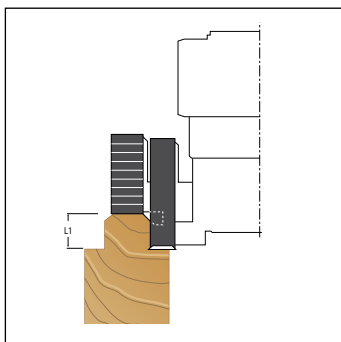
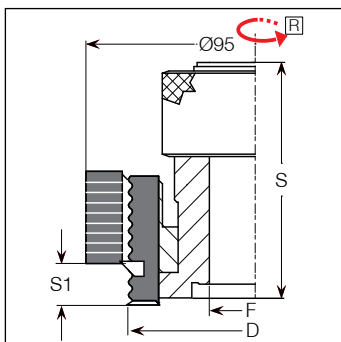

TAGLIO / SEZIONATURA SAWING

DIAMANTE DIAMOND

FRESATURA CUTTING

PANTOGRAFATURA ROUTING

FORATURA BORING

MANDRINI / ATTACCHI CHUCKS & CLAMPING SYSTEM

RICAMBI E LAVORAZIONI SUPP. SPARE PARTS & ADD. WORKING



Egyenes profilú marók  
élzáró gépekre



Kanten-Füge-Fräser (gerade)  
zum Kantenanleimen



Fraises d'affleurage droites



Фрезы для  
кромкооблицовочных  
станков

## F400

## HW Marók élzáró gépekre

TAGLIO / SEZIONATURA  
SAWING

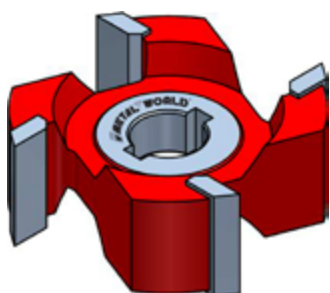

Edzett acélból készült test • Beforrasztott vidia vágóélek • Panelek élének megmunkálására alkalmas • Szimmetrikus kivétel • HOMAG és SCM gépeken használhatók

Body in hardened and tempered steel • HW brazed cutting edges • Suitable for edge banding panels • Symmetric execution • Can be used on HOMAG and SCM machines

DIAMANTE  
DIAMOND



ÉLZÁRÓ GÉPEKRE SZERELÉSHEZ

D	S	S1	F	Z	Cikkszám
70	25	10,5	16+2CH	4	■ F400M07025AA

Spec.

F400M99

● = Készleten van ■ = Szállítási idő 20 munkanap △ = Rendelésre



ÉLZÁRÓ GÉPEKRE SZERELÉSHEZ

D	S	S1	F	Z	Cikkszám
70	20	11	16+2CH	6	■ F400M07020AA
80	20	11	16+2CH	6	■ F400M08020AA

Spec.

F400M99

FRESATURA  
CUTTING

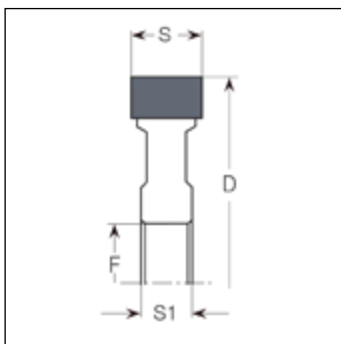

PANTOGRAFATURA  
ROUTING



Egyenes profilú  
marók élzáró gépekre



Kanten-Füge-Fräser (gerade)  
zum Kantenanleimen



Fraises d'affleurage droites



Фрезы для  
кромкооблицовочных  
станков

## F410

## HW Marók élzáró gépekre

FORATURA  
BORING

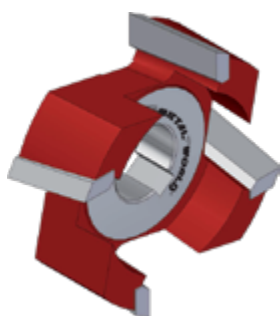

Edzett acélból készült test • Beforrasztott vidia vágóélek • Oldalsó felfogás • Forgácslap, laminált, furnérozott, melamin bevonatos panelek élmarására alkalmas • IMA gépeken használható

Body in hardened and tempered steel • HW brazed cutting edges • Lateral hub • Suitable to edge banding laminated, veneered or melaminated panels • Can be used on IMA machines

MANDRINI / ATTACCHI  
CHUCKS & CLAMPING SYSTEM

IMA ÉLZÁRÓ GÉPEKRE SZERELÉSHEZ

D	S	S1	F	Z	Balos cikkszám	Jobbos cikkszám
70	25	12,5	20+2CH	4	■ F410M070254L	■ F410M070254R
70	25	12,5	20+2CH	6	■ F410M070256L	■ F410M070256R

Spec.

F410M99L

F410M99R

● = Készleten van ■ = Szállítási idő 20 munkanap △ = Rendelésre

RICAMBI E LAVORAZIONI SUPP.  
SPARE PARTS & ADD. WORKING

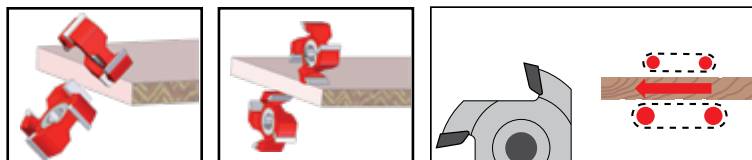
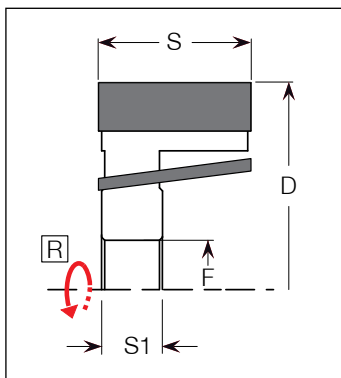

Minden védjegy a jogos birtokosának a tulajdona. All trademarks are the property of their respective holders.



# F420

## HW Marók élzáró gépekre

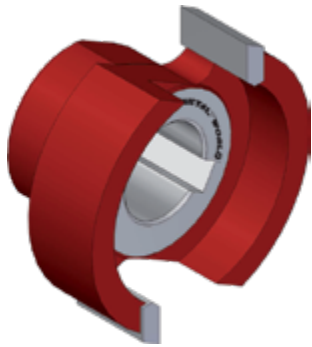

Edzett acélból készült test • Beforrasztott vidia vágóélek • Túlnyúló felfogás • Forgácslap, laminált, furnérozott, melamin bevonatos panelek élmarására alkalmas • BIESSE, HOMAG, IMA, SCM gépeken használható

Body in hardened and tempered steel • HW brazed cutting edges • Overhang hub • Suitable to edge banding laminated, veneered or melaminated panels • Can be used on BIESSE, HOMAG, IMA, SCM machines

### BIESSE ÉLZÁRÓ GÉPEKRE SZERELÉSHEZ

D	S	S1	F	Z	Balos cikkszám	Jobbos cikkszám
70	20	22	20+2CH	4	F420M702004L	F420M702004R
70	20	22	20+2CH	6	F420M702006L	F420M702006R
80	20	22	20+2CH	6	F420M802006L	F420M802006R

Spec.

F420M99L

F420M99R

● = Készleten van ■ = Szállítási idő 20 munkanap ▲ = Rendelésre

### HOMAG ÉS IMA ÉLZÁRÓ GÉPEKRE SZERELÉSHEZ

D	S	F	Z	Balos cikkszám	Jobbos cikkszám
70	25	HSK25	4	F420M702504L	F420M702504R
70	35	HSK25	4	F420M703504L	F420M703504R

Spec.

F420M99L

F420M99R

### scm ÉLZÁRÓ GÉPEKRE SZERELÉSHEZ

D	S	S1	F	Z	Balos cikkszám	Jobbos cikkszám
48	13,6	20	16+2CH	2	F420M481362L	F420M481362R
48	13,6	20	16+2CH	3	F420M481363L	F420M481363R
48,5	25	14	16+2CH	4	F420M482504L	F420M482504R

Spec.

F420M99L

F420M99R

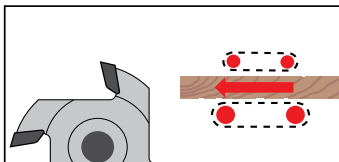
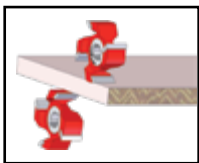
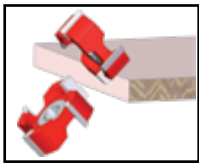
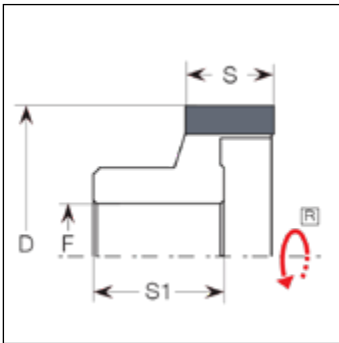

TAGLIO / SEZIONATURA  
SAWING

DIAMANTE  
DIAMOND

FRESATURA  
CUTTING

PANTOGRAFATURA  
ROUTING

FORATURA  
BORING

MANDRINI / ATTACCHI  
CHUCKS & CLAMPING SYSTEM

RICAMBI E LAVORAZIONI SUPP.  
SPARE PARTS & ADD. WORKING

Központi felfogású marók élzáró gépekre

Sprossenkonterfräser

Fraises d'affleurage

Фрезы для кромкооблицовочных станков

## F435

## HW Marók élzáró gépekre

TAGLIO / SEZIONATURA SAWING

DIAMANTE DIAMOND

FRESATURA CUTTING

PANTOGRAFATURA ROUTING

FORATURA BORING

MANDRINI / ATTACCHI CHUCKS & CLAMPING SYSTEM

RICAMBI E LAVORAZIONI SUPP. SPARE PARTS & ADD. WORKING

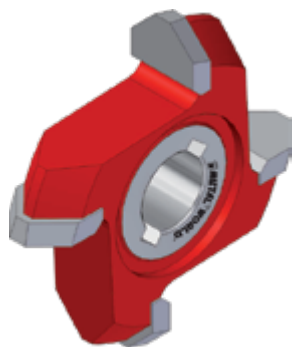

Edzett acélból készült test • Beforrasztott vídia vágóélek • Központi felfogás • Forgácslap, laminált, furnézott, melamin bevonatos panelek élmárására alkalmas • SCM gépeken használható

Body in hardened and tempered steel • HW brazed cutting edges • Overhang hub • Suitable to edge banding laminated, veneered or melaminated panels • Can be used on BIESSE, HOMAG, IMA, SCM machines

### scm ÉLZÁRÓ GÉPEKRE SZERELÉSHEZ

D	S	S1	F	Z	B	Cikkszám
64	16	12	16+2CH	4	20°	F435M064164A
69	16	12	16+2CH	4	45°	F435M069164A

Spec.						F435M99
-------	--	--	--	--	--	---------

● = Ready in stock ■ = Delivery time 20 working days △ = On request

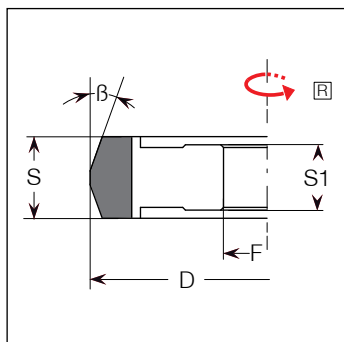

Többrádiusos marók élzáró gépekre

Multiradienfräser

Fraises d'affleurage multiprofiles

Фрезы мультирадиусные для кромкооблицовочных станков

## F480

## HW Többrádiusos marók élzáró gépekre

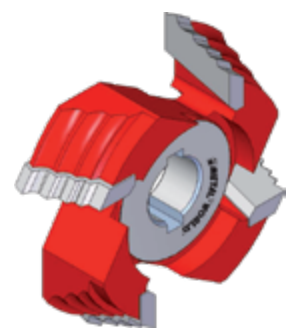

Edzett acélból készült test • Beforrasztott vídia vágóélek • ABS élek lekerekítésére alkalmas • BIESSE, SCM élzáró gépeken használható

Body in hardened and tempered steel • HW brazed cutting edges • Lateral hub • Suitable to round ABS edges • Can be used on BIESSE and SCM machines

### BIESSE ÉLZÁRÓ GÉPEKRE SZERELÉSHEZ

D	D1	S	S1	F	Z	Balos cikkszám	Jobbos cikkszám
70	61	23	15	16+2CH	4	F480M07023AL	F480M07023AR

Spec.						F480M99L	F480M99R
-------	--	--	--	--	--	----------	----------

● = Készleten van ■ = Szállítási idő 20 munkanap △ = Rendelésre

### scm ÉLZÁRÓ GÉPEKRE SZERELÉSHEZ

D	D1	S	S1	F	Z	Balos cikkszám	Jobbos cikkszám
77,4	63	20,4	10,8	16+2CH	4	F480M07720AL	F480M07720AR

Spec.						F480M99L	F480M99R
-------	--	--	--	--	--	----------	----------

Minden védjegy a jogos birtokosának a tulajdona. All trademarks are the property of their respective holders.





**F495**



**Mini csónakmaró**

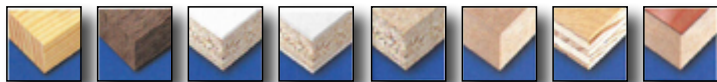

Edzett acélból készült test • Beforrasztott vidia vágóélek • Lamello® javítóhornyok kimarására javasolt • Alkalmas természetes fák, nyers és bevonatos forgácslap vagy MDF panelek megmunkálására • Kézi és CNC gépeken használható

Obtained from hardened and tempered steel • Carbide tip • Indicated for grooving cuts for Lamello® • Suitable to cut chipboard or MDF panels lined on both sides • Used on manual machine and CNC

● = Készleten van   ■ = Szállítási idő 20 munkanap   △ = Rendelésre

D	S	F	ill. furatok	Z	Balos cikkszám	Jobbos cikkszám
100	8	22	4,5–9,5/36	4	● F495M100008L	● F495M100008R
Spec.					F495M99L	F495M99R

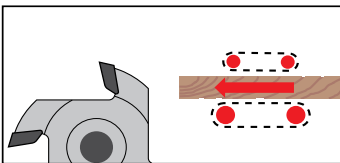
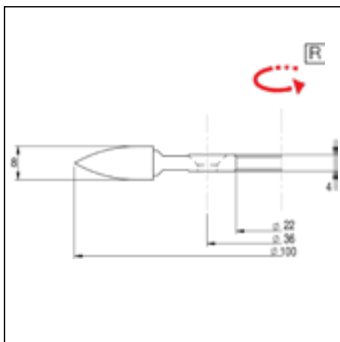

TAGLIO / SEZIONATURA  
SAWING

DIAMANTE  
DIAMOND

FRESATURA  
CUTTING

PANTOGRAFATURA  
ROUTING

FORATURA  
BORING

MANDRINI / ATTACCHI  
CHUCKS & CLAMPING SYSTEM

RICAMBI E LAVORAZIONI SUPP.  
SPARE PARTS & ADD. WORKING



PROFESSIONAL TOOLS ALL OVER THE WORLD